

DVD HOME THEATER SOUND SYSTEM

DVX-S60

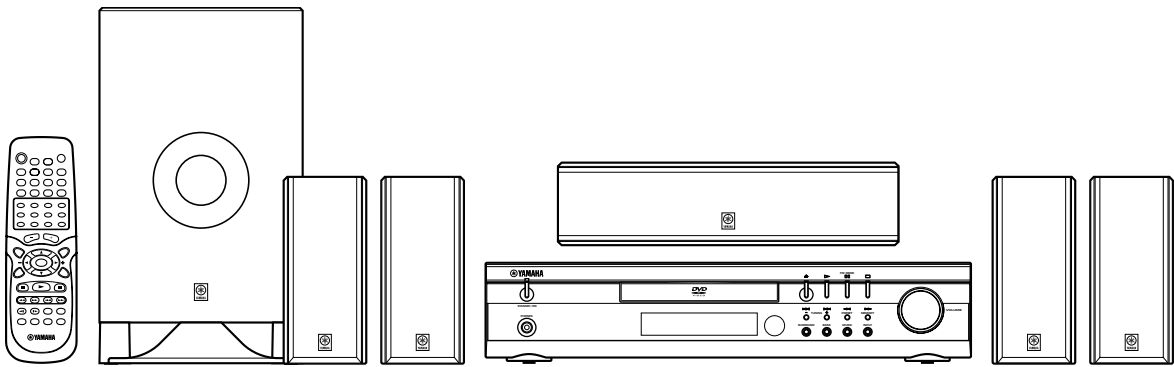

DVX-S60: DVR-S60 + NX-S60S + NX-S60C + SW-S60

IMPORTANT SAFETY INSTRUCTIONS

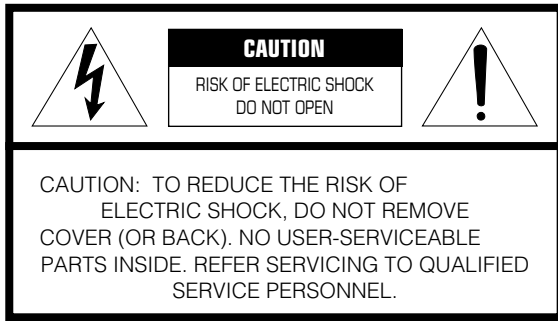

• Explanation of Graphical Symbols

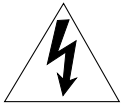

The lightning flash with arrowhead symbol, within an equilateral triangle, is intended to alert you to the presence of uninsulated "dangerous voltage" within the product's enclosure that may be of sufficient magnitude to constitute a risk of electric shock to persons.



The exclamation point within an equilateral triangle is intended to alert you to the presence of important operating and maintenance (servicing) instructions in the literature accompanying the appliance.

WARNING

TO REDUCE THE RISK OF FIRE OR ELECTRIC SHOCK, DO NOT EXPOSE THIS UNIT TO RAIN OR MOISTURE.

- 1 Read Instructions – All the safety and operating instructions should be read before the product is operated.
 - 2 Retain Instructions – The safety and operating instructions should be retained for future reference.
 - 3 Heed Warnings – All warnings on the product and in the operating instructions should be adhered to.
 - 4 Follow Instructions – All operating and use instructions should be followed.
 - 5 Cleaning – Unplug this product from the wall outlet before cleaning. Do not use liquid cleaners or aerosol cleaners. Use a damp cloth for cleaning.
 - 6 Attachments – Do not use attachments not recommended by the product manufacturer as they may cause hazards.
 - 7 Water and Moisture – Do not use this product near water – for example, near a bath tub, wash bowl, kitchen sink, or laundry tub; in a wet basement; or near a swimming pool; and the like.
 - 8 Accessories – Do not place this product on an unstable cart, stand, tripod, bracket, or table. The product may fall, causing serious injury to a child or adult, and serious damage to the product. Use only with a cart, stand, tripod, bracket, or table recommended by the manufacturer, or sold with the product. Any mounting of the product should follow the manufacturer's instructions, and should use a mounting accessory recommended by the manufacturer.
 - 9 A product and cart combination should be moved with care. Quick stops, excessive force, and uneven surfaces may cause the product and cart combination to overturn.
 - 10 Ventilation – Slots and openings in the cabinet are provided for ventilation and to ensure reliable operation of the product and to protect it from overheating, and these openings must not be blocked or covered. The openings should never be blocked by placing the product on a bed, sofa, rug, or other similar surface. This product should not be placed in a built-in installation such as a bookcase or rack unless proper ventilation is provided or the manufacturer's instructions have been adhered to.
- 
- 11 Power Sources – This product should be operated only from the type of power source indicated on the marking label. If you are not sure of the type of power supply to your home, consult your product dealer or local power company. For products intended to operate from battery power, or other sources, refer to the operating instructions.
 - 12 Grounding or Polarization – This product may be equipped with a polarized alternating current line plug (a plug having one blade wider than the other). This plug will fit into the power outlet only one way. This is a safety feature. If you are unable to insert the plug fully into the outlet, try reversing the plug. If the plug should still fail to fit, contact your electrician to replace your obsolete outlet. Do not defeat the safety purpose of the polarized plug.
 - 13 Power-Cord Protection – Power-supply cords should be routed so that they are not likely to be walked on or pinched by items placed upon or against them, paying particular attention to cords at plugs, convenience receptacles, and the point where they exit from the product.
 - 14 Lightning – For added protection for this product during a lightning storm, or when it is left unattended and unused for long periods of time, unplug it from the wall outlet and disconnect the antenna or cable system. This will prevent damage to the product due to lightning and power-line surges.
 - 15 Power Lines – An outside antenna system should not be located in the vicinity of overhead power lines or other electric light or power circuits, or where it can fall into such power lines or circuits. When installing an outside antenna system, extreme care should be taken to keep from touching such power lines or circuits as contact with them might be fatal.
 - 16 Overloading – Do not overload wall outlets, extension cords, or integral convenience receptacles as this can result in a risk of fire or electric shock.
 - 17 Object and Liquid Entry – Never push objects of any kind into this product through openings as they may touch dangerous voltage points or short-out parts that could result in a fire or electric shock. Never spill liquid of any kind on the product.
 - 18 Servicing – Do not attempt to service this product yourself as opening or removing covers may expose you to dangerous voltage or other hazards. Refer all servicing to qualified service personnel.
 - 19 Damage Requiring Service – Unplug this product from the wall outlet and refer servicing to qualified service personnel under the following conditions:
 - a) When the power-supply cord or plug is damaged,
 - b) If liquid has been spilled, or objects have fallen into the product,
 - c) If the product has been exposed to rain or water,
 - d) If the product does not operate normally by following the operating instructions. Adjust only those controls that are covered by the operating instructions as an improper adjustment of other controls may result in damage and will often require extensive work by a qualified technician to restore the product to its normal operation,
 - e) If the product has been dropped or damaged in any way, and
 - f) When the product exhibits a distinct change in performance - this indicates a need for service.
 - 20 Replacement Parts – When replacement parts are required, be sure the service technician has used replacement parts specified by the manufacturer or have the same characteristics as the original part. Unauthorized substitutions may result in fire, electric shock, or other hazards.
 - 21 Safety Check – Upon completion of any service or repairs to this product, ask the service technician to perform safety checks to determine that the product is in proper operating condition.
 - 22 Wall or Ceiling Mounting – The unit should be mounted to a wall or ceiling only as recommended by the manufacturer.

- 23 Heat** – The product should be situated away from heat sources such as radiators, heat registers, stoves, or other products (including amplifiers) that produce heat.
- 24 Outdoor Antenna Grounding** – If an outside antenna or cable system is connected to the product, be sure the antenna or cable system is grounded so as to provide some protection against voltage surges and built-up static charges. Article 810 of the National Electrical Code, ANSI/NFPA 70, provides information with regard to proper grounding of the mast and supporting structure, grounding of the lead-in wire to an antenna discharge unit, size of grounding conductors, location of antenna discharge unit, connection to grounding electrodes, and requirements for the grounding electrode.

Note to CATV system installer:

This reminder is provided to call the CATV system installer’s attention to Article 820-40 of the NEC that provides guidelines for proper grounding and, in particular, specifies that the cable ground shall be connected to the grounding system of the building, as close to the point of cable entry as practical.

EXAMPLE OF ANTENNA GROUNDING

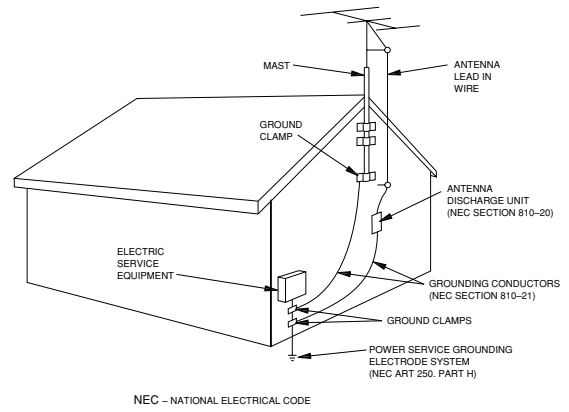

FCC INFORMATION (for US customers)

- 1. IMPORTANT NOTICE : DO NOT MODIFY THIS UNIT!**
This product, when installed as indicated in the instructions contained in this manual, meets FCC requirements. Modifications not expressly approved by Yamaha may void your authority, granted by the FCC, to use the product.
- 2. IMPORTANT :** When connecting this product to accessories and/or another product use only high quality shielded cables. Cable/s supplied with this product **MUST** be used. Follow all installation instructions. Failure to follow instructions could void your FCC authorization to use this product in the USA.
- 3. NOTE :** This product has been tested and found to comply with the requirements listed in FCC Regulations, Part 15 for Class “B” digital devices. Compliance with these requirements provides a reasonable level of assurance that your use of this product in a residential environment will not result in harmful interference with other electronic devices.
This equipment generates/uses radio frequencies and, if not installed and used according to the instructions found in the users manual, may cause interference harmful to the operation of other electronic devices.

Compliance with FCC regulations does not guarantee that interference will not occur in all installations. If this product is found to be the source of interference, which can be determined by turning the unit “OFF” and “ON”, please try to eliminate the problem by using one of the following measures:

Relocate either this product or the device that is being affected by the interference.

Utilize power outlets that are on different branch (circuit breaker or fuse) circuits or install AC line filter/s.

In the case of radio or TV interference, relocate/reorient the antenna. If the antenna lead-in is 300 ohm ribbon lead, change the lead-in to coaxial type cable.

If these corrective measures do not produce satisfactory results, please contact the local retailer authorized to distribute this type of product. If you can not locate the appropriate retailer, please contact Yamaha Electronics Corp., U.S.A. 6660 Orangethorpe Ave, Buena Park, CA 90620.

The above statements apply **ONLY** to those products distributed by Yamaha Corporation of America or its subsidiaries.

We Want You Listening For A Lifetime





YAMAHA and the Electronic Industries Association’s Consumer Electronics Group want you to get the most out of your equipment by playing it at a safe level. One that lets the sound come through loud and clear without annoying blaring or distortion – and, most importantly, without affecting your sensitive hearing.

Since hearing damage from loud sounds is often undetectable until it is too late, YAMAHA and the Electronic Industries Association’s Consumer Electronics Group recommend you to avoid prolonged exposure from excessive volume levels.

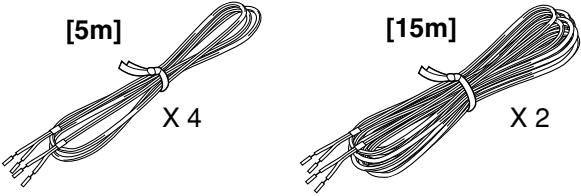
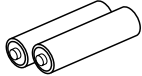
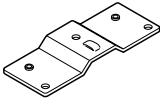

CHECKING THE ACCESSORIES

● Check your package to make sure it contains the following items.

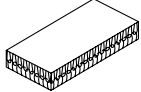
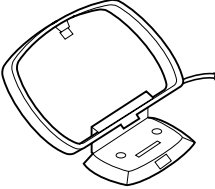
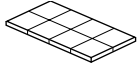
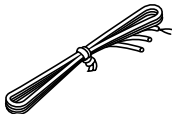
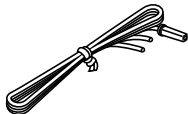
DVR-S60	NX-SW60 (NX-S60S x 4, NX-S60C, SW-S60)
<ul style="list-style-type: none"> ● Remote control 	<ul style="list-style-type: none"> ● Speaker cables 
<ul style="list-style-type: none"> ● Batteries (size AA, UM/SUM-3, R6, HP-7) 	<ul style="list-style-type: none"> ● Mounting brackets (for NX-S60S)  X 4
<ul style="list-style-type: none"> ● Audio pin cable 	<ul style="list-style-type: none"> ● Screws (for NX-S60S)  X 4
<ul style="list-style-type: none"> ● Video pin cable 	<ul style="list-style-type: none"> ● Fasteners (for NX-S60C)  X 2
<ul style="list-style-type: none"> ● AM loop antenna 	<ul style="list-style-type: none"> ● Nonskid pads (for NX-S60S)  X 2
<ul style="list-style-type: none"> ● Indoor FM antenna  <p>(U.S.A., Canada, Australia, China, Korean and General models)</p>  <p>(U.K. and Europe models)</p>	



Manufactured under license from Dolby Laboratories.
 "Dolby", "Pro Logic", and the double-D symbol are trademarks of Dolby Laboratories.



"DTS" and "DTS Digital Surround" are registered trademarks of Digital Theater Systems, Inc.

This product incorporates copyright protection technology that is protected by method claims of certain U.S. patents and other intellectual property rights owned by Macrovision Corporation and other rights owners. Use of this copyright protection technology must be authorized by Macrovision Corporation, and is intended for home and other limited viewing uses only unless otherwise authorized by Macrovision Corporation. Reverse engineering or disassembly is prohibited.

CAUTION: READ THIS BEFORE OPERATING YOUR SYSTEM.

- 1 To assure the finest performance, please read this manual carefully. Keep it in a safe place for future reference.
- 2 Do not install this equipment in a confined space, such as a book case or built in cabinet.
- 3 Locate this system away from other electrical appliances, motors, or transformers to avoid humming sounds. To prevent fire or electrical shock, do not place this system where it may get exposed to dripping or splashing, and never put any objects filled with liquids, such as vases, on the top of the system.
- 4 Do not expose this system to sudden temperature changes from cold to hot, and do not locate this system in a environment with high humidity (i.e. a room with a humidifier) to prevent condensation inside this system, which may cause an electrical shock, fire, damage to this system, and/or personal injury.
- 5 Avoid installing this system in a place where foreign objects and liquid might fall. It might cause a fire, damage to this system and/or personal injury. Do not place the following objects on this system:
 - Other components, as they may cause damage and/or discoloration on the surface of this system.
 - Burning objects (i.e. candles), as they may cause fire, damage to this system, and/or personal injury.
 - Containers with liquid in them, as they may cause electrical shock to the user and/or damage to this system.
- 6 Do not cover this system with a newspaper, tablecloth, curtain, etc. in order not to obstruct heat radiation. If the temperature inside this system rises, it may cause fire, damage to this system, and/or personal injury.
- 7 Do not plug in this system to a wall outlet until all connections are complete.
- 8 Do not operate this system upside-down. It may overheat, possibly causing damage.
- 9 Do not use force on switches, knobs and/or cables.
- 10 When disconnecting the power cable from the wall outlet, grasp the plug; do not pull the cable.
- 11 Do not clean this system with chemical solvents; this might damage the finish. Use a clean, dry cloth.
- 12 Only voltage specified on this system must be used. Using this system with a higher voltage than specified is dangerous and may cause fire, damage to this system, and/or personal injury. YAMAHA will not be held responsible for any damage resulting from use of this system with a voltage other than specified.
- 13 To prevent damage by lightning, disconnect the power cable from the wall outlet during an electrical storm.
- 14 Take care of this system so that no foreign objects and/or liquid drops inside this system.
- 15 Do not attempt to modify or fix this system. Contact qualified YAMAHA service personnel when any service is needed. The cabinet should never be opened for any reasons.
- 16 When not planning to use this system for long periods of time (i.e. vacation), disconnect the AC power plug from the wall outlet.
- 17 Be sure to read the "TROUBLESHOOTING GUIDE" section on common operating errors before concluding that this system is faulty.
- 18 Before moving this system, press STANDBY/ON to set this system in the standby mode, and disconnect the AC power plug from the wall outlet.
- 19 **VOLTAGE SELECTOR (General model only)**
The VOLTAGE SELECTOR on the rear panel of DVR-S60 must be set for your local main voltage BEFORE plugging into the AC main supply.
Voltages are 110–120V/220–240V AC, 50/60 Hz.

This system is not disconnected from the AC power source as long as it is connected to the wall outlet, even if this system itself is turned off. This state is called the standby mode. In this state, this system is designed to consume a very small quantity of power.

IMPORTANT

Please record the serial number of DVR-S60 in the space below.

MODEL:

Serial No.:

The serial number is located on the rear of DVR-S60.

Retain this Owner's Manual in a safe place for future reference.

FOR CANADIAN CUSTOMERS

To prevent electric shock, match wide blade of plug to wide slot and fully insert.

This Class B digital apparatus complies with Canadian ICES-003.

■ For U.K. customers

If the socket outlets in the home are not suitable for the plug supplied with this appliance, it should be cut off and an appropriate 3 pin plug fitted. For details, refer to the instructions described below.

Note

- The plug severed from the mains lead must be destroyed, as a plug with bared flexible cord is hazardous if engaged in a live socket outlet.

■ Special Instructions for U.K. Model

IMPORTANT

THE WIRES IN MAINS LEAD ARE COLOURED IN ACCORDANCE WITH THE FOLLOWING CODE:

Blue: NEUTRAL

Brown: LIVE

As the colours of the wires in the mains lead of this apparatus may not correspond with the coloured markings identifying the terminals in your plug, proceed as follows:

The wire which is coloured BLUE must be connected to the terminal which is marked with the letter N or coloured BLACK. The wire which is coloured BROWN must be connected to the terminal which is marked with the letter L or coloured RED.

Making sure that neither core is connected to the earth terminal of the three pin plug.

DANGER

Visible laser radiation when open. Avoid direct exposure to beam. When this system is plugged to the wall outlet, do not place your eyes close to the opening of the disc tray and other openings to look into inside.

The laser component in this product is capable of emitting radiation exceeding the limit for Class 1.

CONTENTS

IMPORTANT SAFETY INSTRUCTIONS	II	VARIOUS DISC PLAYING FUNCTIONS	18
CHECKING THE ACCESSORIES	IV	Selecting a DVD menu [DVD]	18
CAUTION	1	Selecting a title menu [DVD]	18
CONTROLS	3	Return button (RETURN) [Video CD]	18
Front panel	3	Chapter (Track) skip	18
Display	3	Title search [DVD]	18
REMOTE CONTROL	4	Chapter search [DVD]	18
Controls	4	Track search [Video CD] [CD]	18
Installing batteries in the remote control	5	Time search	18
Using the remote control	5	Fast play	18
SPEAKER PLACEMENT	6	Slow-motion play	18
Placing the speakers	6	Still picture (Pause)	18
Placing the center speaker	6	Frame by frame advance play [DVD] [Video CD]	18
Mounting the front and surround speakers	7	Picture zoom [DVD] [Video CD]	19
BASIC CONNECTIONS	8	Viewing from a desired camera angle (Multi-Angle) [DVD]	19
Speaker connections	8	Angle replay [DVD]	19
Antenna connections	9	Repeat play	19
Connecting to a TV with the video pin cable	9	Programmed play [Video CD] [CD]	19
ADDITIONAL CONNECTION EXAMPLES	10	Selecting subtitle language [DVD]	20
Connecting to a TV with an S video cable	10	Selecting audio soundtrack language (Multi-Language) [DVD]	20
Connecting to a TV with a component video cable	10	Changing the audio channel output [Video CD]	20
VCR connections	10	Selecting on-screen information	20
Progressive-scan TV connections	11	MP3 CD OPERATION	21
Headphones	11	MP3 CD information	21
BASIC OPERATION	12	MP3 CD play	21
Turning the power on and off	12	LANGUAGE CODE LIST	22
Direct start function	12	LISTENING TO VIDEO SOURCES	23
Selecting the source	12	LISTENING TO THE RADIO	23
Adjusting the volume	12	Automatic/Manual tuning	23
To reduce the volume temporarily	12	To preset stations	23
Bass extension	12	Listening to preset stations	23
Selecting the sound mode	12	To receive FM stereo broadcasts	23
What to do if	12	TIMER OPERATION	24
ADJUSTING THE CLOCK	12	Using the timer	24
SELECTING THE SURROUND MODE	13	Using the sleep timer	24
Selecting Dolby Pro Logic mode	13	TROUBLESHOOTING GUIDE	25
PLAYABLE DISCS	14	SPECIFICATIONS	26
DISC PLAY	15		
Preparations	15		
Loading a disc	15		
Starting play	15		
Stopping play	15		
SETTINGS ON THE SET UP MENU	16		
Common procedures of settings	16		
Language	16		
Display	16		
Speaker	17		
Parental	17		

CONTROLS

Front panel

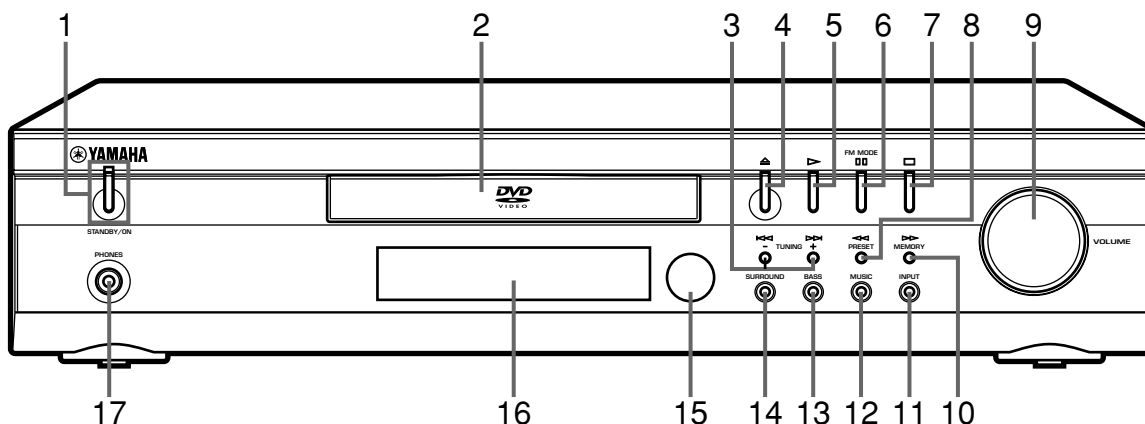

1. STANDBY/ON button, Standby indicator
2. Disc tray
3. ◀◀/TUNING – button, ▶▶/TUNING + button
4. Open/Close button (▲)
5. Play button (▶)
6. FM MODE button [see page 23.]/Pause button (⏸)
7. Stop button (■)
8. ◀◀/PRESET button
9. VOLUME control

10. ▶▶/MEMORY button
11. INPUT button
12. MUSIC button [see page 12.]
13. BASS button [see page 12.]
14. SURROUND button [see page 13.]
15. Remote control sensor
16. Display
17. PHONES jack

Display

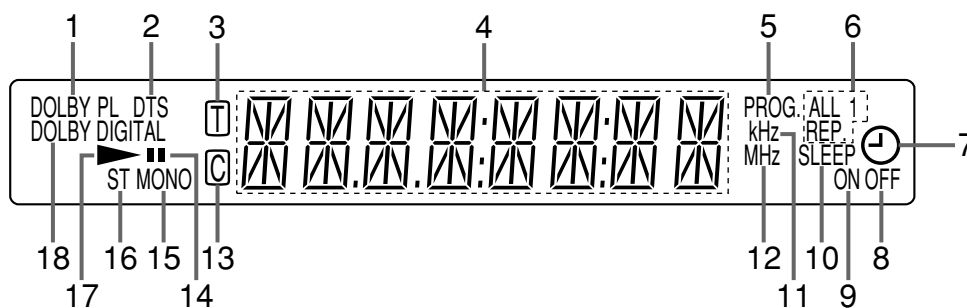

1. Dolby Pro Logic indicator (DOLBY PL)
2. DTS indicator (DTS)
3. Title and Track indicator (T)
4. Message or number indicators (Title, chapter, track, playing time or other information)
5. Program indicator (PROG.) [see page 19, 23.]
6. Repeat mode indicators (ALL, 1, REP.) [see page 19.]
7. Timer indicator (⌚) [see page 24.]
8. Timer off indicator (OFF) [see page 24.]
9. Timer on indicator (ON) [see page 24.]
10. Sleep indicator (SLEEP) [see page 24.]

11. Kilohertz indicator (kHz)
12. Megahertz indicator (MHz)
13. Chapter indicator (C)
14. Pause indicator (⏸)
15. FM mono indicator (MONO) [see page 23.]
16. FM stereo indicator (ST) [see page 23.]
17. Play indicator (▶)
18. Dolby Digital indicator (DOLBY DIGITAL)

REMOTE CONTROL

Note:

In this instruction manual, any operation of pressing a button while pressing the SHIFT button is described as follows.

Example: "Press SHIFT + 2 ANGLE buttons."

Controls

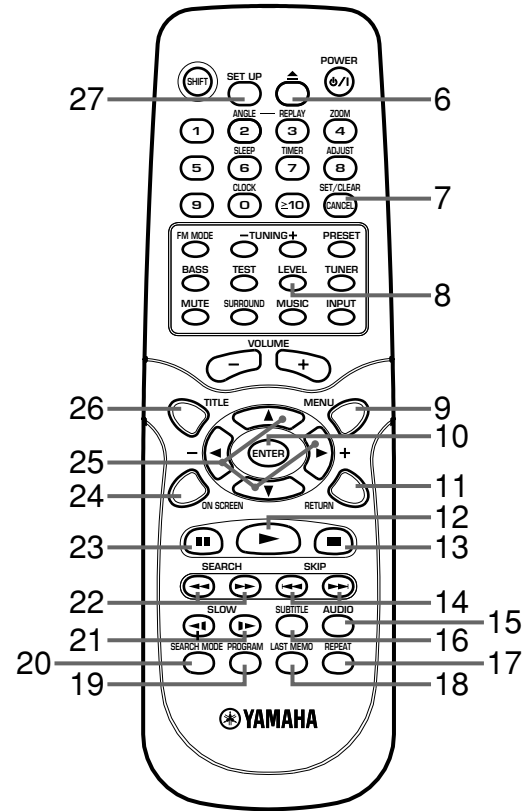
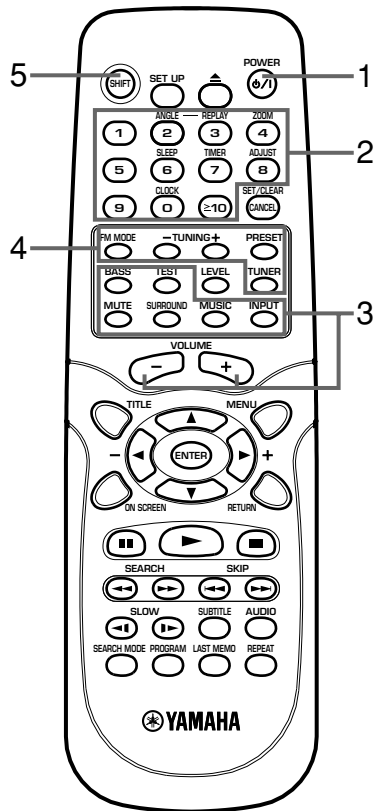

1. POWER button (⏻)
2. Number and other function buttons
Number buttons (1–9, 0, ≥10)
ANGLE button [see page 19.]
ANGLE–REPLAY button [see page 19.]
ZOOM button [see page 19.]
SLEEP button [see page 24.]
TIMER button [see page 24.]
ADJUST button [see page 12.]
CLOCK button [see page 12.]
3. Amplifier controls
INPUT button
TEST tone [see page 13.]
SURROUND button [see page 13.]
BASS button [see page 12.]
MUSIC button [see page 12.]
MUTE button [see page 12.]
VOLUME –/+ buttons
4. Tuner controls
TUNER button (Tuner/Band select button)
PRESET button (Preset tuning button)
[see page 23.]
TUNING –/+ buttons [see page 23.]
FM MODE button [see page 23.]
5. SHIFT button

6. Open/Close (▲) button
7. SET/CLEAR button [see page 24.]
CANCEL button [see page 18, 19.]
8. LEVEL button [see page 13.]
9. MENU button [see page 18.]
10. ENTER button
11. RETURN button [see page 18.]
12. Play button (▶)
13. Stop button (■)
14. SKIP ◀◀/▶▶ buttons
15. AUDIO button [see page 20.]
16. SUBTITLE button [see page 20.]
17. REPEAT button [see page 19.]
18. Last memory button (LAST MEMO) [see page 15.]
19. PROGRAM button [see page 19.]
20. SEARCH MODE button [see page 18.]
21. SLOW ◀|/▶ buttons [see page 18.]
22. SEARCH ◀◀/▶▶ buttons
23. Pause button (⏸)
24. ON SCREEN button [see page 20.]
25. ▲, ▶, ▼, ◀ buttons
26. TITLE button [see page 18.]
27. SET UP button [see page 16.]

Installing batteries in the remote control

Insert the batteries in the correct direction by aligning the + and – marks on the batteries with the polarity markings (+ and –) inside the battery compartment.

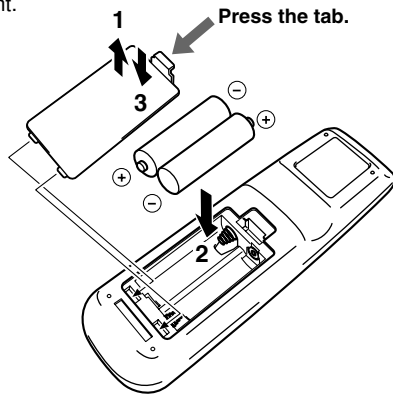

1. Press the tab on the battery compartment cover in the direction of the arrow and remove the cover.
2. Insert the two batteries (AA, R06, UM-3 type) with + and – oriented properly.
3. Attach the cover so that it snaps into place.

Notes on batteries

- Change all of the batteries if you notice a decrease in the operating range of the remote control.
- Do not use old batteries together with new ones.
- Do not use different types of batteries (such as alkaline and manganese batteries) together. Read the packaging carefully as these different types of batteries may have the same shape and color.
- If the batteries have leaked, dispose of them immediately. Avoid touching the leaked material or letting it come into contact with clothing, etc. Clean the battery compartment thoroughly before installing new batteries.

Using the remote control

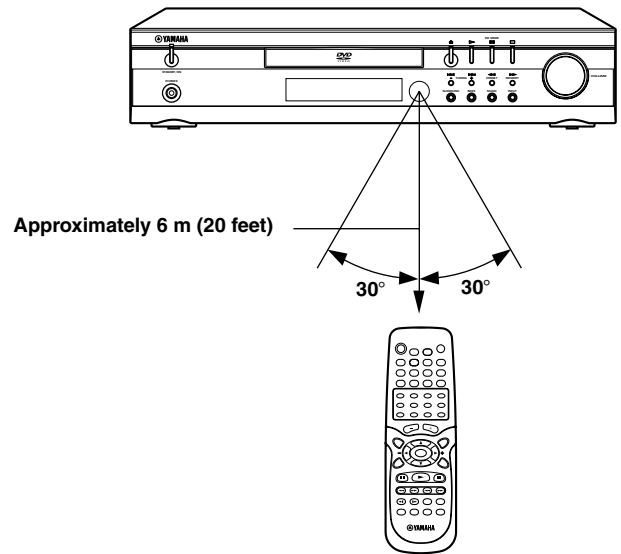

Handling the remote control

- Do not spill water or other liquids on the remote control.
- Do not drop the remote control.
- Do not leave or store the remote control in the following types of conditions:
 - high humidity or temperature such as near a heater, stove or bath;
 - dusty places; or
 - in places subject to extremely low temperatures.

SPEAKER PLACEMENT

Before making connections, place all speakers in their respective positions. The positioning of the speakers is important because it controls the whole sound quality of this system.

Place the speakers depending on your listening position by following the instructions below.

Note:

- In this speaker package, the same speakers (NX-S60S) are used for the front and surround speakers.
- Although the speaker system in this system is magnetically shielded, it may still affect the color on the television monitor when using this system near the television. Adjust the relative positions of this system and the television if this happens.

Placing the speakers

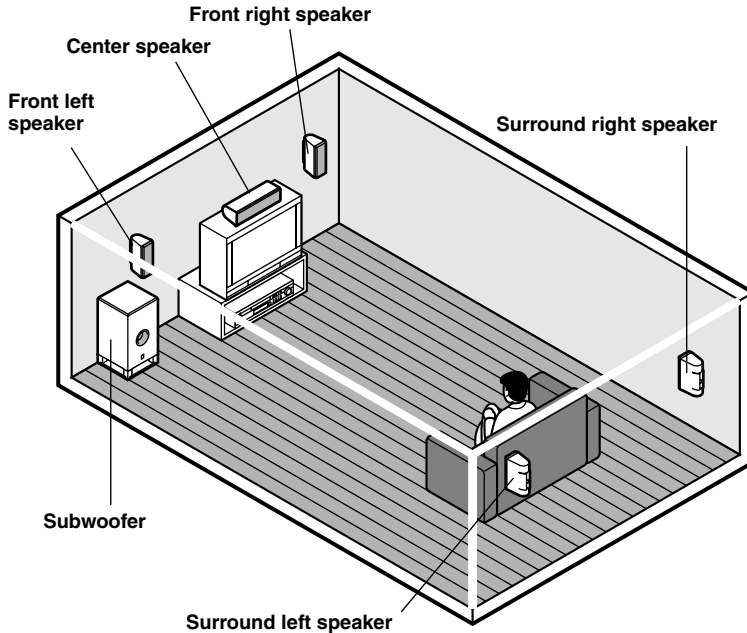

Front speakers: On both sides of and at approximately the same height as the TV set.

Surround speakers: Behind your listening position, facing slightly inward. About 1.8 m (approx. 6 feet) from the floor.

Center speaker: Precisely between the front speakers.

Subwoofer: The position of the subwoofer is not so critical because low bass tones are not highly directional.

QD-Bass TECHNOLOGY

QD-Bass Technology

QD-Bass (Quatre Dispersion Bass) technology uses square, pyramid-shaped reflective plates to radiate the sound in four horizontal directions.

Caution for carrying the subwoofer

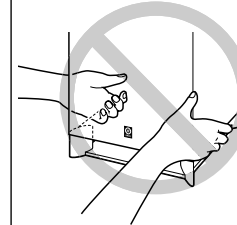

Do not insert your hands into the openings at the lower part of the subwoofer when carrying it. If you touch the inside speaker unit, it may be damaged. Remove the warning label put by the factory setting when using the subwoofer.

Placing the center speaker

You can place the speaker on top of the TV if the top is flat, on the floor under the TV, or inside the TV rack. Be sure to place the speaker in a stable position.

When placing the speaker on top of the TV, to prevent the speaker from falling, attach the provided fasteners at two points on the bottom of the speaker and on the top of the TV.

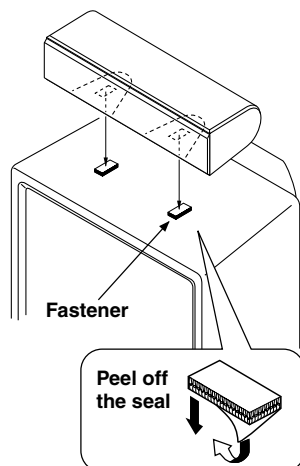

Note:

- Do not place the speaker on top of a TV whose area is smaller than the bottom of the speaker. If placed, the speaker may fall and cause injury.
- Do not place the speaker on top of a TV if the top is inclined.
- Do not touch the adhesive surface after peeling off the seal as this will weaken its adhesive strength.
- Thoroughly wipe clean the surface where the fastener is to be applied. Note that adhesive strength is weakened if the surface is dirty, oily or wet and that this may cause the center speaker to drop.

Mounting the front and surround speakers

Mount the speakers on a shelf, rack or directly on the floor, or hang them on the wall.

To mount the speakers on a wall by using the holes on the speakers' back panels

1. Fasten screws into a firm wall or wall support as shown in the figure.

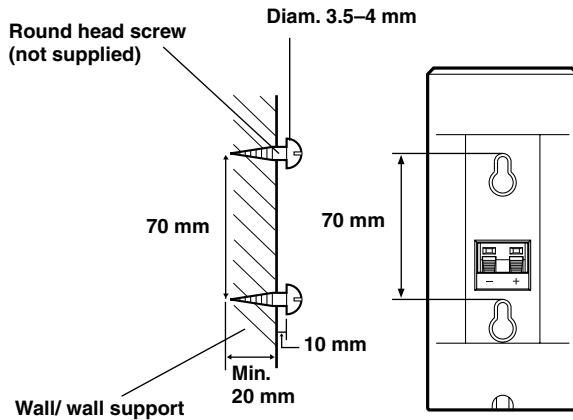

2. Hang the speaker by mounting the holes on the protruding screws.
 - * Make sure that the screws are securely caught by the narrow parts of the holes.

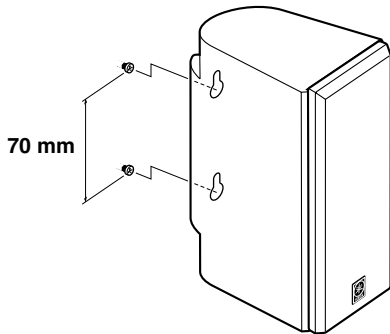

WARNING

- Each speaker weighs 0.9 kg (2 lbs.). Do not mount them on thin plywood or a wall composed of a soft surface material. If mounted, the screws may pull out of the flimsy surface and the speakers may fall. This may damage the speakers or cause personal injury.
- Do not affix the speakers to a wall using nails, adhesives, or any other unstable hardware. Long-term use and vibrations may cause the speakers to fall.
- To avoid accidents resulting from tripping over loose speaker cables, fix the cables to the wall.
- Select an appropriate position on the wall to mount the speaker so that no one will injure his/her head or face.

Using the Yamaha Speaker Stand SPS-80 (option)

By using the Yamaha Speaker Stand SPS-80, speakers can be placed on the floor.

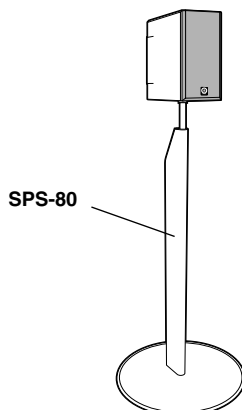

* The SPS-80 is not available in some areas.

Placing the the front/surround speakers

When placing the speakers on a flat surface, attach the included nonskid pads to the corners on the bottom of the speakers. This prevents the speakers from sliding around.

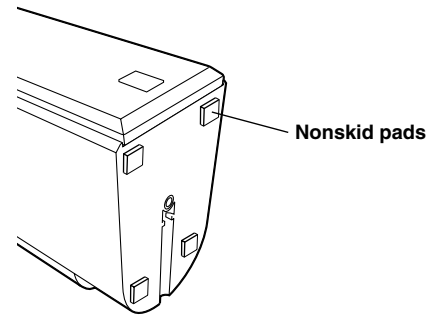

If you want to mount a speaker on a commercially available speaker stand for the front/surround speakers

The provided mounting bracket with 1 pair of screw holes (at an interval of 60 mm) can be used to mount the speaker on a speaker stand.

* Those screw holes can be used with M4 screws only.

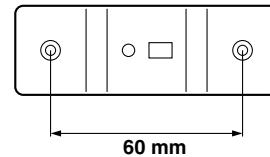

1. Attach the bracket to the bottom of the speaker by using the provided screw so that the convex part of the bracket fits in the grooved part on the bottom of the speaker.

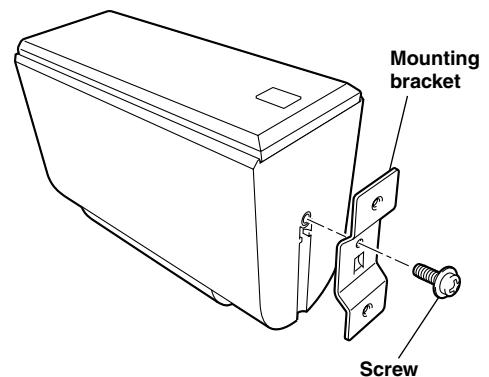

2. Mount the speaker on the speaker stand by using the screw holes on the bracket.

Note:

The mounting bracket is provided for each speaker.

Note:

- Be careful not to let the speaker system fall, it might cause damage or serious injuries.
- If you use another speaker system, please change the settings of "Speaker" under "SETTINGS ON THE SET UP MENU" to the proper settings for the speaker system. (See Page 17.)

BASIC CONNECTIONS

Selecting TV system (for General model only)

Before connecting, set the TV SYSTEM switch (rear of the unit) to the position of your local TV system (PAL or NTSC).

After all connections have been made, connect the power cable to an AC outlet.

Note:

- Do not connect the power cable to an AC outlet until all connections have been made.
- The system is not completely disconnected from the AC outlet when the STANDBY/ON button is set to the standby mode.

Speaker connections

Be sure all connections are made correctly, that is to say, L (left) to L, R (right) to R, "+" to "+" and "-" to "-".

Label of the speaker cable	Color tube	Use
FRONT R	Red	Front right speaker
FRONT L	White	Front left speaker
CENTER	Green	Center speaker
REAR R	Gray	Surround right speaker
REAR L	Blue	Surround left speaker
SUBWOOFER	Purple	Subwoofer

Note:

- The label of the speaker is attached to each speaker cable. Connect the speakers in accordance with the labels.
- Connect the color tube of the speaker cable to the plus (+) side of each speaker. If the polarity of the speaker connections is incorrect, the sound will be unnatural and lack bass.
- A cover is attached to the end of the speaker cable. Connect the speakers after removing the cover.

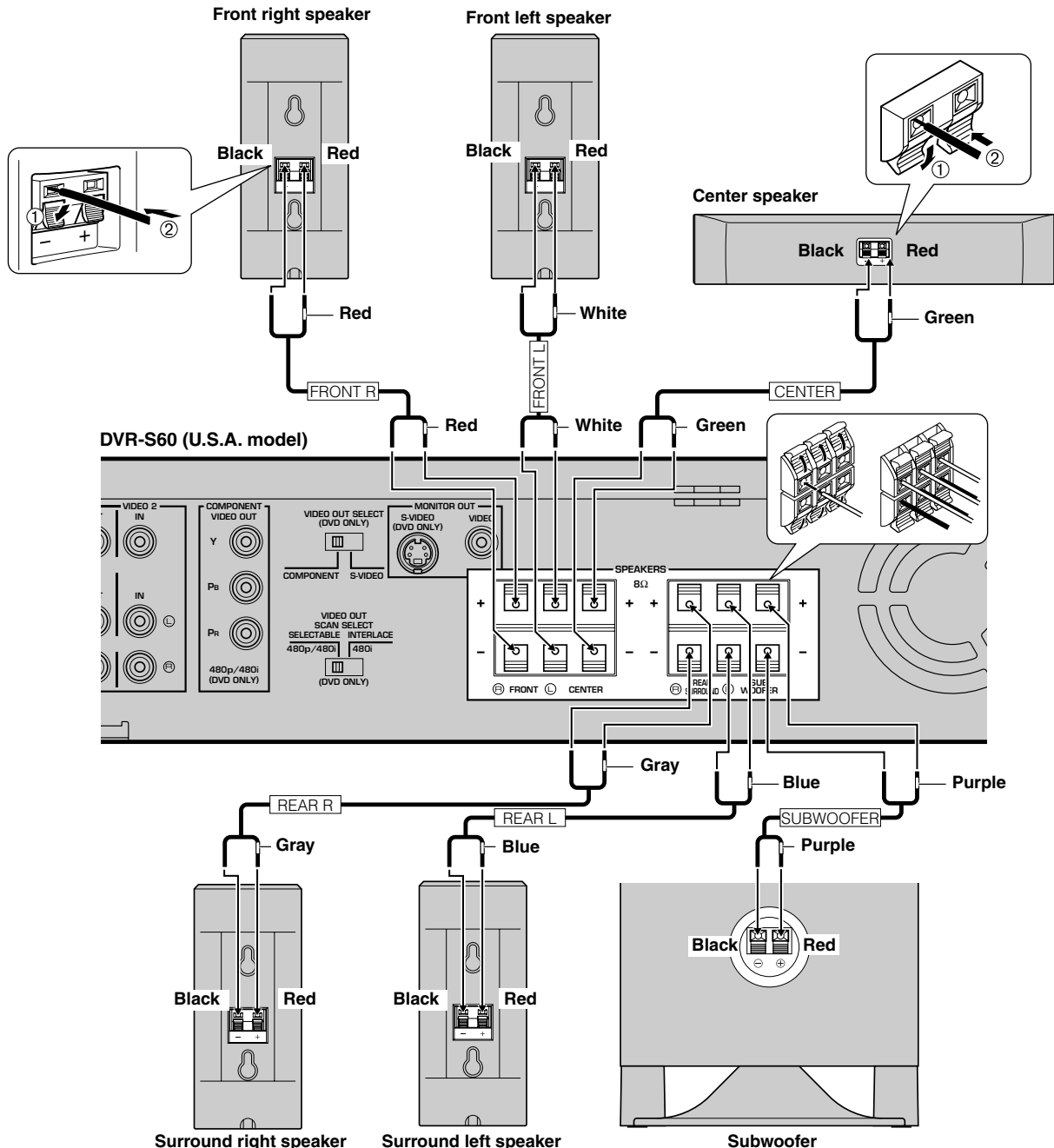

Antenna connections

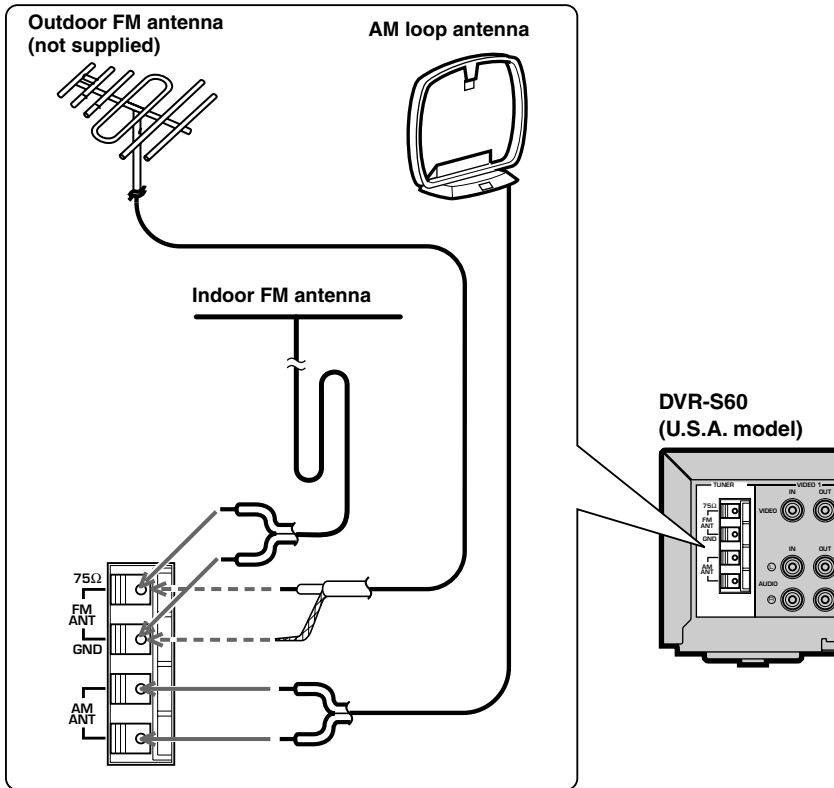

AM loop antenna

Set up the loop antenna.

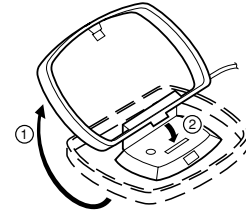

Unwind the antenna wires, then connect them to the AM ANT terminals. Place the loop antenna in a position which yields the best AM reception, or attach it to a wall or other surface.

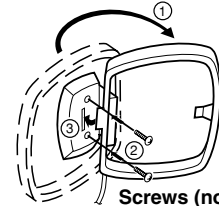

Note:

To minimize noise, the speakers, power cable and any other cable should not come close to the indoor or external antenna cable and AM loop antenna. Do not place the antenna cables close to the system.

In areas close to a transmitter the simple indoor antenna is sufficient to receive broadcasts. Extend the antenna wire as straight as possible and, while listening to the sound from the system, secure it in a position which yields minimal distortion and noise.

In fringe areas or where reception is distorted or noisy, an external antenna (not supplied) should be connected instead of the simple indoor antenna. Consult your dealer.

Connecting to a TV with the video pin cable

Connect the included or commercially available video pin cable between the MONITOR OUT VIDEO jack of the unit and the video input jack of the TV.

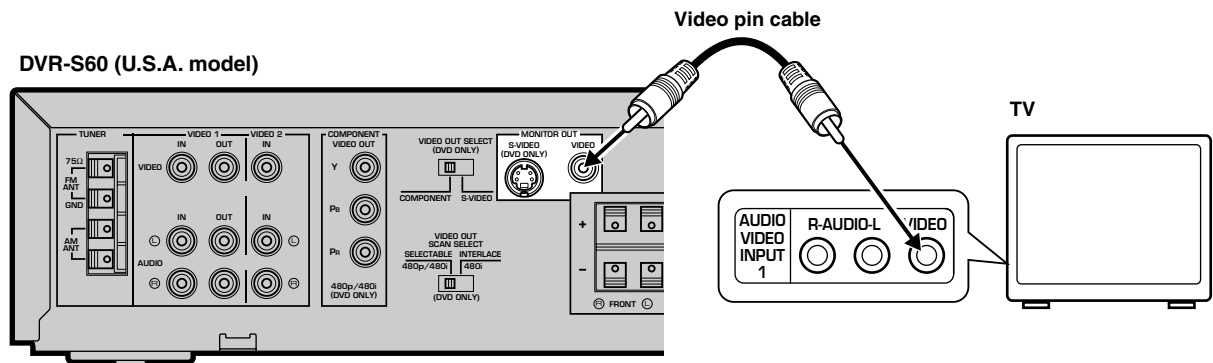

Notes on connections

- Please refer to the instruction manuals for the components that you are connecting (TV, etc.).
- When you connect the unit to your TV and other equipment, be sure to turn off the power and disconnect all of the equipments from the AC outlet until all the connections have been made.
- **Do not connect the MONITOR OUT (S VIDEO/VIDEO) and COMPONENT VIDEO OUT jacks of the unit to a VCR directly. The playback picture will be distorted because DVD discs are copy protected.**
- Please consult your local audio/video dealer for more details.

ADDITIONAL CONNECTION EXAMPLES

For connections, use the included or commercially available connection cables suitable for respective connections.

Connecting to a TV with an S video cable

Please follow the steps below before turning on the power.

1. If your TV has an S video input jack, connect the unit as shown in the figure. You can enjoy clearer picture playback.
2. Set the VIDEO OUT SELECT switch to S VIDEO.

DVR-S60 (U.S.A. model)

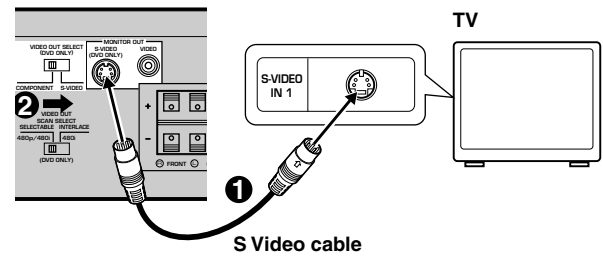

Connecting to a TV with a component video cable

Please follow the steps below before turning on the power.

1. If your TV has component video input jacks, connect the unit as shown in the figure. You can enjoy high quality picture playback.
2. Set the VIDEO OUT SELECT switch to COMPONENT.

DVR-S60 (U.S.A. model)

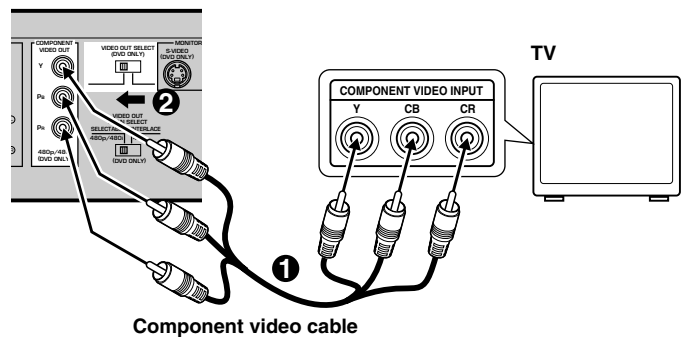

VCR connections

With this connection, it is possible to watch and listen to videocassettes or other video equipment.

Connect the 1st VCR as shown in figure 1-4.

If using the 2nd VCR or other video equipment, connect it as shown in figure 5-6.

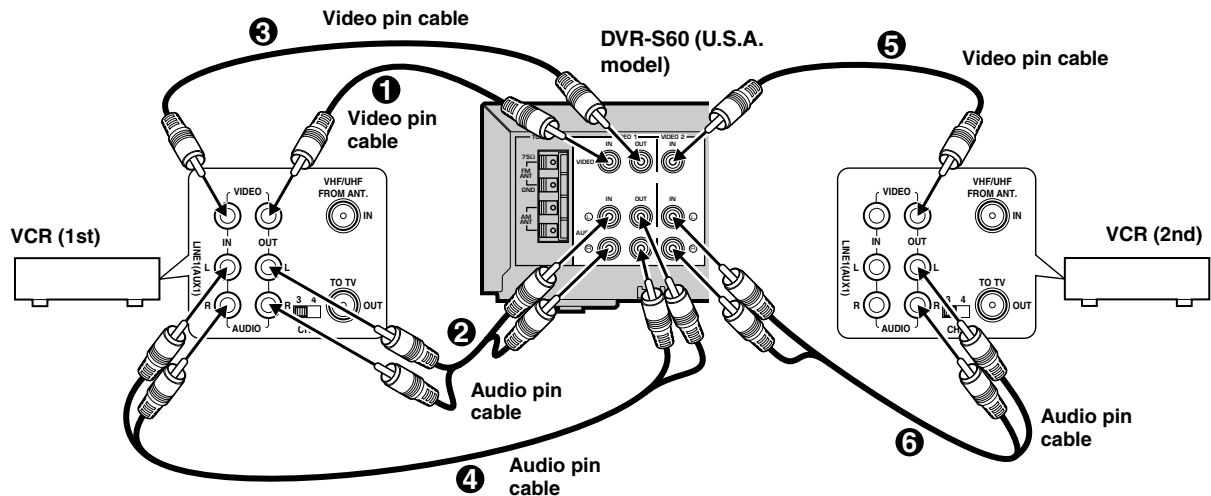

Note:

- The picture from the VCR may be distorted in some cases.
- If you use the VCR, you must connect the video pin cable between the MONITOR OUT VIDEO jack of the unit and the video input jack of the TV. There are no VCR video signals from the MONITOR OUT S VIDEO and COMPONENT VIDEO OUT jacks of the unit.

<For U.S.A., Canada and Korean models>

Be sure to check and/or change the settings of the VIDEO OUT SELECT and VIDEO OUT SCAN SELECT switches before turning on this system. If the setting of either or both switches is changed during play, picture may be disturbed or disappear from the monitor. In such a case, turn this system off and then on again.

<For U.K., Europe, Australia, China and General models>

Be sure to check and/or change the setting of the VIDEO OUT SELECT switch before turning on this system. If the setting of this switch is changed during play, picture may be disturbed or disappear from the monitor. In such a case, turn this system off and then on again.

Do not connect this system to a TV through a VCR. If you do so, the picture may not be played back properly due to the copyright protection technology incorporated in this system.

Progressive-scan TV connections (for U.S.A., Canada and Korean models only)

Your TV must be capable of handling progressive scanning and have component video input capability.

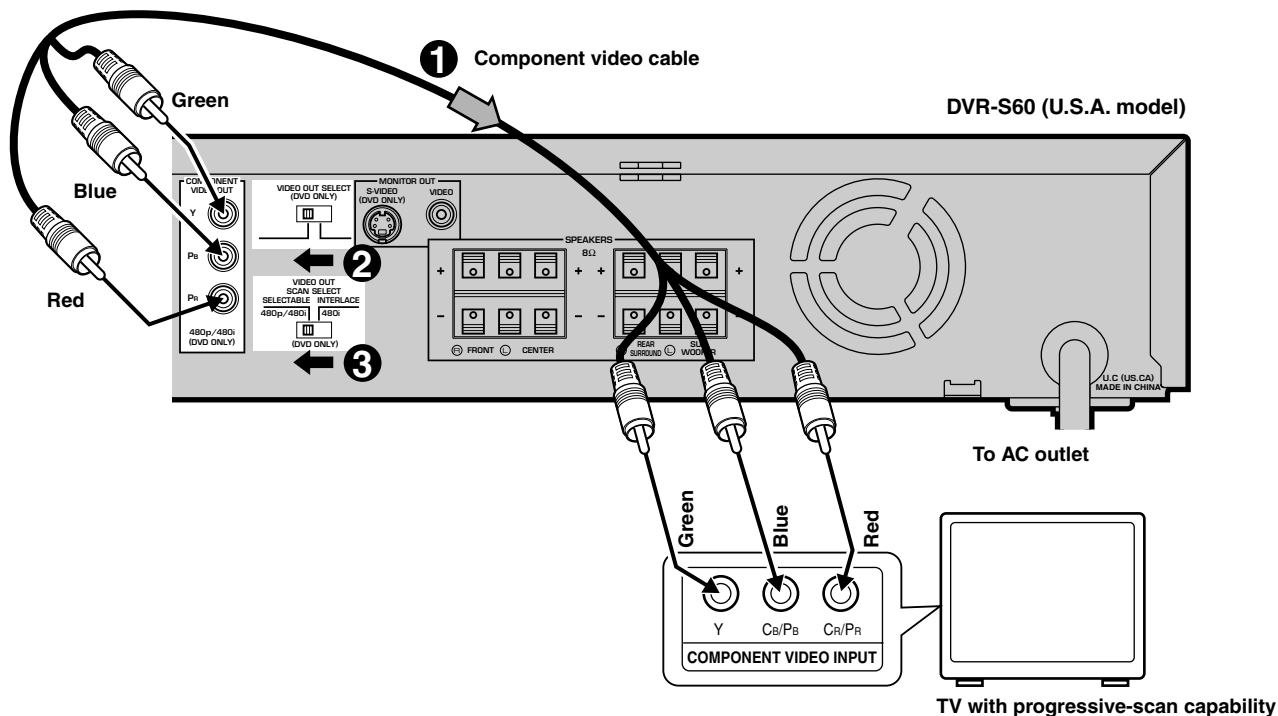

Please follow the steps below before turning on the power.

1. Connect the component video cable (not supplied) between the COMPONENT VIDEO OUT jacks of the unit and the COMPONENT VIDEO INPUT jacks of the TV.
2. Set the VIDEO OUT SELECT switch to the COMPONENT position.
3. Set the VIDEO OUT SCAN SELECT switch to the SELECTABLE position.

After all connections and settings on the rear panel are completed, turn on the power of this system and the TV, then make the following setting.

4. Select "COMPONENT OUTPUT: PROGRESSIVE" in "Display" on the SETTINGS ON THE SET UP MENU. (See page 16.)

Notes:

- Please refer to the instruction manual of your TV.
- When you connect the unit to your TV, be sure to turn off the power and disconnect both units from the wall outlet until all the connections have been made.
- After the above connections have been made, there are no video signals from the MONITOR OUT VIDEO and VIDEO 1 VIDEO OUT jacks.

Do not connect the unit to a VCR directly. The playback picture will be distorted because DVD video discs are copy protected.

Progressive Scanning

While interlaced scanning produces one frame of video in two fields, progressive scanning creates one frame in one field. Conventional interlaced scanning constitutes one second with 30 frames (60 fields), but progressive scanning constitutes it with 60 frames from scratch. Progressive scanning can reproduce sharper picture with high resolution for still image or other picture containing long texts or horizontal lines. This model has compliance with 480p (progressive) system.

Interlaced scanning



Progressive scanning

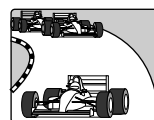

Headphones

Connect stereo headphones (not supplied) to the PHONES jack for monitoring or for private listening. The speakers are automatically disconnected when headphones are connected.

BASIC OPERATION

Turning the power on and off

Press the STANDBY/ON button. The STANDBY indicator goes out. (After connecting the power cable, when you press the STANDBY/ON button for the first time, the volume-reset feature automatically sets the initial volume level.)

To turn the power off, press the STANDBY/ON button again. The STANDBY indicator lights up.

- When the power cable is connected to the AC outlet, the unit can be controlled from the remote control.

Direct start function

If the following buttons are pressed when the unit is in the standby mode, the unit turns on automatically and the selected source is activated.

Main unit ►, ▲
Remote control ►, TUNER, ▲

Selecting the source

Press the INPUT button to select the desired source. Each time the button is pressed, the display changes as follows:

DVD → VIDEO 1 → VIDEO 2 → FM → AM → . . .

- When the source selection is changed, disc play is automatically stopped.

Adjusting the volume

Turn the VOLUME control (or press the + or – VOLUME button on the remote control). The volume level appears on the display (VOL 0 – VOL 39, MAX).

To reduce the volume temporarily (using the remote control)

Press the MUTE button. The “MUTE” indicator flashes on the front panel display. To restore the previous volume setting, press the MUTE button again.

Bass extension

Press the BASS button to select the desired bass boost effect.

BASS OFF → BASS ON1 → BASS ON2 → BASS OFF . . .

Selecting the sound mode

Press the MUSIC button to select the sound mode matching the source to be listened to.

POP: Pops, etc.
CLASSIC: Classical music, etc.
ROCK: Rock music, etc.
JAZZ: Jazz, etc.

What to do if...

If the operation of the unit or display is not normal,

1. Disconnect the power cable.
2. While pressing both BASS and MUSIC buttons on the main unit at the same time, connect the power cable. “RESET” briefly appears on the display.
3. Resume operation.

ADJUSTING THE CLOCK (Using the remote control)

Example: To set “PM 6:30”

1. Press the STANDBY/ON button to turn the power on.
2. Press the SHIFT + 0 CLOCK buttons. “AM 12:00” flashes.
3. Press the SHIFT + 8 ADJUST buttons,

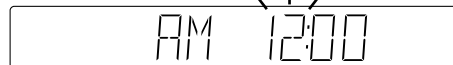

The hour display flashes.

4. Press the TUNING – or + button to set the “hours”.

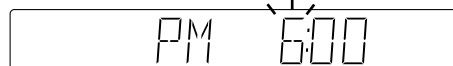

5. Press the SHIFT + 8 ADJUST buttons.

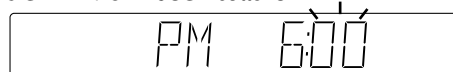

The minute display flashes.

6. Press the TUNING – or + button to set the “minutes”.

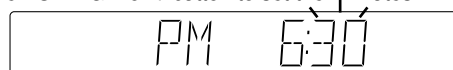

7. Press the SHIFT + 8 ADJUST buttons. The clock starts.

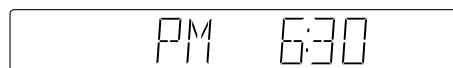

- The time can be set accurately by pressing the SHIFT + 8 ADJUST buttons when a time signal is heard.

To display the clock during operation

Press the SHIFT + 0 CLOCK buttons. Press both buttons again to return to the original display.

Note:

When the display flashes because of a power failure, reset the time.

SELECTING THE SURROUND MODE

Press the SURROUND button to select the surround mode. Each time the button is pressed, the surround mode changes as follows:

DOLBY PL → DOLBY 3 → DOLBY D → DTS → THEATER → HALL
→ SURR OFF → DOLBY PL . . .

Note:
Some discs may restrict the selection.

DOLBY PL: Dolby Pro Logic mode
When playing a program source encoded with Dolby Surround sound (video tape, laser disc, DVD, etc.) (Fig. A)

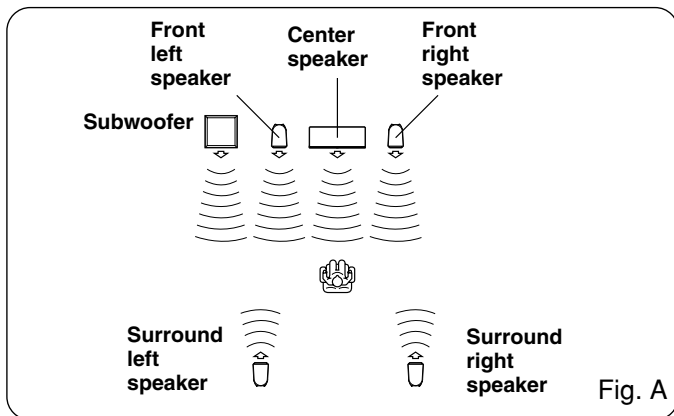

DOLBY 3: 3 channel mode
Using only the Front left, Center, Front right and Subwoofer speakers (Fig. B)

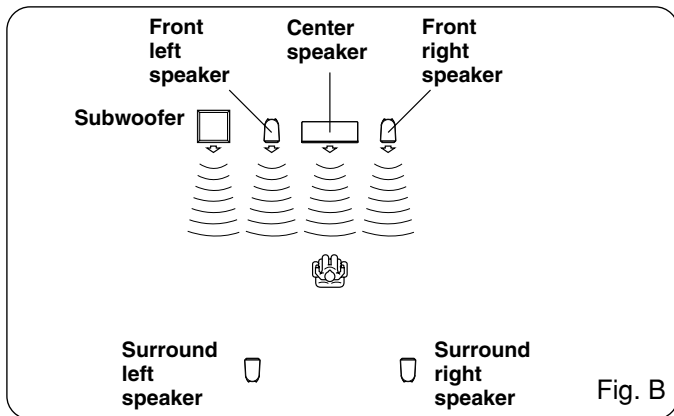

DOLBY D:
Dolby Digital 5.1 Channel mode
When DVD disc encoded with Dolby Digital 5.1 Channel is played back, you can select "DOLBY D". (Fig. A)

Note:
Center or Surround speakers do not sound with some discs.

DTS:
DTS Digital Surround mode
When DVD disc encoded with DTS Digital Surround System (5.1ch) is played back, you can select "DTS". (Fig. A)

Note:
Center or Surround speakers do not sound with some discs.

THEATER: "Theater" effect
HALL: "Hall" effect
When playing a program source which is not encoded with Dolby Surround or DTS sound (Fig. A)

SURR OFF: Normal stereo sound
Using only the Front left, Front right and Subwoofer speakers (Fig. C)

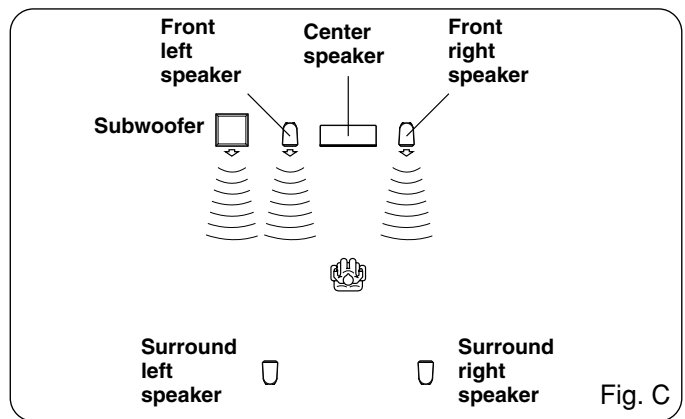

Selecting Dolby Pro Logic mode

If you play a program source encoded with Dolby Surround or DTS sound (video tape, laser disc, DVD etc.), follow the steps below.

Please use the remote control at the listening position.

1. Press the + or – VOLUME button to adjust the sound level from the speakers.
2. Press the SURROUND button repeatedly until "DOLBY PL" appears.
3. Press the TEST button. "TTONE" appears and "FL" flashes.
The test tone will be heard from each speaker sequentially as follows:

TTONE
FL (Front left speaker)
C (Center speaker)
FR (Front right speaker)
RS (Surround right speaker)
LS (Surround left speaker)

4. Press the + or – VOLUME button until the test tone turns into a comfortable level.

If the test tone level is not the same from each speaker, you may need fine adjustment of the volume level. Please follow the steps as below.

Note:

If you make no operation, the original display returns after approximately a minute.

- 1) Press the TEST button to turn the test tone off.
- 2) Press the SURROUND button to select the desired surround mode.
- 3) Press the LEVEL button. "FNLT 0" appears.
- 4) Press the ENTER button repeatedly to select the speaker.

Display (Speaker)
FNLT (Front left speaker)
CENT (Center speaker)
FNTR (Front right speaker)
SURR (Surround right speaker)
SURL (Surround left speaker)
SUBW (Subwoofer)





- 5) Press the ► or ◀ button to adjust the volume level. (FNLT/FNTR: "0" to "–10", CENT/SURR/SURL/SUBW: "+10" to "–10".)
 - 6) Press the ENTER button.
 - 7) Repeat step 4) to 6) for another speaker, if necessary.
 - 8) Press the LEVEL button again to turn it off.
5. Press the TEST button to turn the test tone off. "TTONE" disappears.
 6. Press the + or – VOLUME button to adjust the volume.

Notes:

- There is no Dolby Surround effect when monaural program material is used.
- When receiving weak FM broadcasts, switch the Dolby Pro Logic off. The sound quality may improve.
- When headphones are connected while any of the surround modes are selected, the surround mode is switched off automatically. The SURROUND button does not function while headphones are connected.
- For other surround mode, please refer to "Selecting Dolby Pro Logic mode" as above.
- This adjustment can be set at each source individually.

PLAYABLE DISCS

The following types of discs can be played on this unit.





Disc type and logo mark		Recorded content	Disc size	Maximum playing time
DVD Video		Audio + Video	12 cm	Approx. 4 hours (Single sided disc) Approx. 8 hours (Double sided disc)
			8 cm	Approx. 80 minutes (Single sided disc) Approx. 160 minutes (Double sided disc)
Video CD	 	Audio + Video	12 cm	74 minutes
			8 cm	20 minutes
Music CD		Audio	12 cm	74 minutes
			8 cm	20 minutes

Region number

Region number (Regional restriction code) is built-in to the DVD player and DVD discs.

There is a region number on the rear of the unit.

The same region number or region number "ALL" of DVD discs can be used on this unit.

Model	Region number of this unit	Discs can be played
U.S.A. and Canada models		"1", "ALL" or a mark which includes the region number "1".
U.K. and Europe models		"2", "ALL" or a mark which includes the region number "2".
Australia model		"4", "ALL" or a mark which includes the region number "4".
General and Korean models		"3", "ALL" or a mark which includes the region number "3".
China model		"6", "ALL" or a mark which includes the region number "6".

DVD disc

There are marks on some DVD disc package.

Examples:



Multiple Languages



Multi-language subtitles



Multi-Angle



Multi-Aspect



Region number

DVD discs are divided into titles, and the titles are sub-divided into chapters.

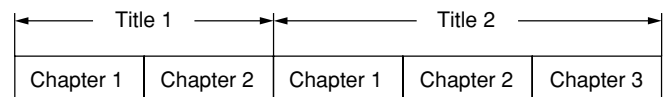

Video CD/Music CD disc

Video CD and Music CD discs are divided into tracks.

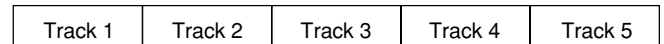

Note:

- Only the above types of discs can be played on this unit. DVD-Audio, DVD-ROM, DVD-RAM, CD-ROM, CDV, CD-G, DVD+RW, DVD-RW, SVCD, CVD, SACD, Divx Video Discs, Photo CD, etc. cannot be played. (Some DVD-R, DVD-RW and DVD+RW discs may be played.)
- This unit can play back CD-R/RW discs that have music data or MP3 files as well. However, some CD-R/RWs can not be played back depending on the recording conditions.
- A CD-R/RW that has no music data or non-MP3 files can not be played back.
- This unit is to be used exclusively with the PAL or NTSC color system. SECAM system discs cannot be used with this unit.

Notes on handling discs

- Do not expose the disc to direct sunlight, high humidity or high temperature for extended periods of time.
- Discs should be returned to their cases after use.
- Do not apply paper or write anything on the disc surface.
- Handle a disc by its edge. Do not touch the recorded surface (glossy side).
- Fingerprints and dust should be carefully wiped off the recorded surface of the disc with a soft cloth.
Wipe in a straight motion from the center to the outside of the disc.
- Never use chemicals such as record cleaning sprays, antistatic sprays or fluids, benzene or thinner to clean discs.
- Do not use a disc printed on its surface by a commercially available label printer.

DISC PLAY

Important note:

- This "DISC PLAY" explains the basic instruction of the DVD player section using the remote control unit.
- Some DVD or Video CD discs have different functions that may not be explained in this instruction manual. You may need extra instructions. In this case, please follow the instructions displayed on the TV screen or the jacket or case of the disc.
- "⊘" may appear on the TV screen during operation. This icon means that the function is not available on the current disc.

Preparations

- Press the STANDBY/ON button to turn on this unit.
- Turn on the TV and select the channel for the DVD player. Select the playback picture size suitable for the aspect ratio of the TV. (See "Display" under "SETTINGS ON THE SET UP MENU" on Page 16.)
- Select the desired language for the screen menus. (See "OSD" – "Language" under "SETTINGS ON THE SET UP MENU" on Page 16.)

Note:

- Do not touch the disc tray while it is moving.
- Never place anything except a disc on the disc tray. Foreign objects can damage the unit.
- Do not apply excessive force to the disc tray.
- Only one disc can be placed on the disc tray.
- To open or close the disc tray, be sure to use the ▲ button. Do not press the disc tray with your hand.

When an operation button is pressed, that operation is displayed on the TV screen. The display turns off after several seconds.

If a disc is loaded, you can turn the unit on and begin play immediately by pressing the ► button.

Loading a disc

1. Press the ▲ button. "OPEN" appears on the display and the disc tray opens.
2. Place the disc with the label facing up on the disc tray.

12 cm disc



8 cm disc

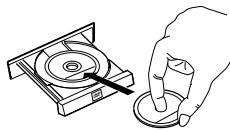

3. Press the ▲ button again to close the disc tray.
 - Some discs may start play automatically.

Starting play

Press the ► button. The DVD function is selected and play starts automatically.

Example:



Note:

- If "NO DISC" appears on the display, load the disc. If the disc is loaded with the label side downward (and it is a single sided disc), or if a badly scratched disc is loaded, "NO DISC" (or "NO PLAY") appears. If this occurs, load the disc correctly or replace the disc.
- The producing method of commercially available discs may differ with each disc. Though there may be a case that the sound becomes intermittent just after the playback of a disc starts, this is dependent on the disc and not a malfunction of this system.

If a menu appears on the TV screen...

Press the ▲, ►, ▼ or ◀ button (or the number buttons), then press the ENTER button to select the desired menu. Playback of the selected menu will start.

Note:

For more details, please refer to the jacket or case of the disc.

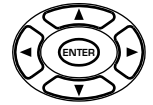

Remote control

Stopping play

- Press the ■ button once. When you press the ► button, play starts automatically from the point where you stopped.
Note:
Some discs may not resume play.
- Press the ■ button twice. The player stops completely. When you press the ► button, play starts from the beginning of the disc.

Continuing play from where you stopped watching (LAST MEMORY PLAY) [DVD]

1. During play, press the LAST MEMO button at the point from which you want to resume play later. "L.M.-STOP" appears on the display. Play stops automatically.
2. Remove the disc or turn off the power.
3. Load the disc (and press the ► button), or turn on the power. "Last Memory Play?" screen appears.

Last Memory Play?

Yes

No

Clear ... The memory is released.

4. Press the ▲ or ▼ button to select "Yes".
5. Press the ENTER button. Play resumes from the point where you stopped. (If desired, press the LAST MEMO button again.)

Note:

- Points on up to 5 discs can be memorized.
- The Last Memory Play mode may not work correctly with some discs.

What is "PBC"?

"PBC" is an abbreviation for "Playback Control" that refers to control codes prerecorded on Video CDs.

During playback of a Video CD with PBC, "PBC" appears on the display.

To lock the disc tray (Using the main unit)

You can lock the disc tray to prevent misuse of young children.

While the disc tray is opened, press the ▲ button until "LOCKED" appears on the TV screen.

- The ▲ button will not function.

To release this mode, press the ▲ button until "UNLOCKED" appears.

SETTINGS ON THE SET UP MENU

Once the following settings have been completed, the unit can always be operated under the same conditions. The settings will be retained in the memory until they are changed, even if the power is turned off.

Common procedures of settings

1. Press the SET UP button in the stop mode. "SET UP MENU" appears on the TV screen.

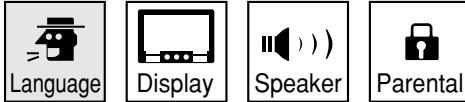

2. Press the ▲, ►, ▼ or ◀ button, then press the ENTER button to select the menu. Please refer to the on-screen instructions.
3. Press the SET UP button to quit this menu.

Example:



OSD: ENGLISH
AUDIO: DISC, ENGLISH, SPANISH, FRENCH, OTHERS
SUBTITLE: DISC, ENGLISH, SPANISH, FRENCH, OTHERS
DVD MENU: DISC, ENGLISH, SPANISH, FRENCH, OTHERS
(DISC: The first priority language recorded on the disc is used.)

Note:

- You cannot switch audio sound track languages if there is only one language recorded on the disc.
- When you play a DVD disc, the player automatically displays the pre-selected subtitle language if it is included on the disc.
- If "OTHERS" is selected, enter the language code. (See "LANGUAGE CODE LIST" on Page 22.)

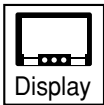

TV TYPE: 4:3 LB, 4:3 PS, 16:9
COMPONENT OUTPUT*: INTERLACE, PROGRESSIVE
PROGRESSIVE MODE*: AUTO, VIDEO, FILM

*: For U.S.A., Canada and Korean models only

TV TYPE:

Select the appropriate setting for your TV screen size.

4:3 LB (Letterbox):

Select when a conventional TV set is connected.

When the wide screen disc is played back, the black bands appear at the top and bottom of screen.



Cut off

4:3 PS (Panscan):

Select when a conventional TV set is connected.

When the wide screen disc is played back, it displays pictures cropped to fill to your TV screen. The left and right edges are cut off.

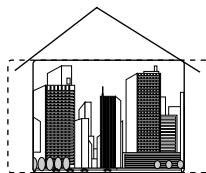

16:9:

Select when a wide screen TV set is connected.

Played in "FULL" size. (Setting the wide screen TV to "FULL" mode is also necessary.)

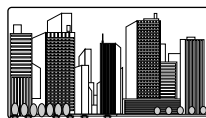

Note:

- The screen size may differ depending on the DVD video discs.
- If you select 16:9 to get rid of the black bands on screen when wide screen disc is played back, picture may be slightly distorted.
- In some discs, even if 4:3 PS is selected, the black bands may remain on the screen.

COMPONENT OUTPUT (U.S.A., Canada and Korean models only):

If you use a conventional TV and connect it to the COMPONENT VIDEO OUT jacks (see page 10), select "INTERLACE".

If you use a TV with progressive-scan capability and connect it to the COMPONENT VIDEO OUT jacks (see page 11), select "PROGRESSIVE".

Note:

- If the VIDEO OUT SELECT and VIDEO OUT SCAN SELECT switches are not correct position, you cannot select "COMPONENT OUTPUT: PROGRESSIVE".
- If you select "COMPONENT OUTPUT: PROGRESSIVE" when using a conventional TV, the TV screen is disturbed. In this case, turn off the power, and then set the VIDEO OUT SCAN switch to the INTERLACE position.

PROGRESSIVE MODE (U.S.A., Canada and Korean models only):

When "COMPONENT OUTPUT: PROGRESSIVE" is selected as above, select "AUTO", "VIDEO" or "FILM".

AUTO:

It automatically selects the VIDEO (Video source) or FILM (Film source) according to the played disc. Normally, select this mode.

VIDEO (Video source):

Major DVD-Video sources consist of video sources and film sources. Select when playing a DVD video disc recorded with a video source or TV program like drama, animation, etc. (30 frames per second, 60 fields).

FILM (Film source):

Major DVD-Video sources consist of video sources and film sources. Select when playing a DVD video disc recorded with a movie film (24 frames per second).

Note:

- Initial setting is "AUTO".
- If picture flickering occurs at "AUTO" mode, select "VIDEO" or "FILM".



D-RANGE CONTROL: OFF, ON
 FRONT SPEAKER: SMALL, LARGE
 CENTER SPEAKER: SMALL, LARGE
 SURROUND SPEAKER: SMALL, LARGE
 SUBWOOFER: YES, NO

These are originally set suitable for the supplied speakers. However, you can also change the settings as you prefer. Make the settings as follows:

D-RANGE CONTROL (Dynamic range control):
 It limits a big sound. Select "ON" or "OFF".

FRONT SPEAKER/CENTER SPEAKER/SURROUND SPEAKER:
 When using the supplied speakers, select "SMALL".

SUBWOOFER:
 When using the supplied subwoofer, select "YES". If not, select "NO".



Setting method

1 ENTER PASSWORD
 Enter a number in 4 digits, then press "ENTER".

* Use the number buttons to enter 4-digit number.



2 To confirm, enter password again, then press "ENTER".

* By following this step, the setting is finished.

Note

If you enter a wrong password, the following message appears on the TV screen. Enter the correct password again.

Invalid password
 Enter a number in 4 digits, then press "ENTER".

Setting the desired parental level

- 1 Enter the password you have set.
- 2 Press ▼ or ▲ button to select "PARENTAL LEVEL".
- 3 Press ► or ◀ button to select the desired level. The selectable levels are as follows.

PARENTAL LEVEL: OFF, 1, 2, 3, 4, 5, 6, 7, 8

To change the password

- 1 Enter the password you have set.
- 2 Press ▼ or ▲ button to select "CHANGE PASSWORD".

CHANGE PASSWORD
 Enter a number in 4 digits, then press "ENTER".

* Use the number buttons to enter 4-digit number.



To confirm, enter password again, then press "ENTER".

* By following this step, the setting is finished.

Parental control

MPAA (Motion Picture Association of America) Guideline is a rating system that provide advance cautionary information to parents about the content of movie programs.

The parental lock level is equivalent to the following MPAA Rating System.

Level 7: NC-17 (No one 17 and under admitted)

Level 6: R (Restricted)

Level 4: PG13 (Parental guidance cautioned)

Level 3: PG (Parental guidance suggested)

Level 1: G (General audiences)

Some DVD discs contain a restriction level which enables parents to prevent playback of discs by children. This DVD player is equipped with a password designed to prevent children changing the level.

You cannot play DVD discs rated higher than the level you selected unless you cancel the parental lock function.

For example, when you select level "5", the DVD player will not play discs with the rating of "6", "7" or "8". The information will appear on the TV screen.

If you forget the password...

Enter "788444" to clear the current password.

Enter a new password and set the parental lock level again.

Note:

Some DVD discs may not respond to the parental lock settings. Make sure this function works with your DVD discs.

For improvement, on screen displays subject to change without notice.

VARIOUS DISC PLAYING FUNCTIONS

"⊘" may appear on the TV screen during operation. This icon means that the function is not available on the current disc.

Selecting a DVD menu [DVD]

1. Press the MENU button. The main menu screen appears.
Note:
Press the MENU button again to resume play.
2. Press the ▲, ►, ▼ or ◀ button (or the number buttons) to select the desired menu then press the ENTER button. The selected menu play starts.

Selecting a title menu [DVD]

1. Press the TITLE button. The title menu appears.
Note:
Press the TITLE button again to resume play from the scene when the TITLE button was first pressed.
2. Press the ▲, ►, ▼ or ◀ button (or the number buttons) to select the desired title then press the ENTER button. The selected title play starts.

Note:

Selecting a DVD or title menu operation may differ depending on the disc used and may not be possible on some discs.

Return button (RETURN) [Video CD]

Normally, it returns to the previous menu when the RETURN button is pressed during play.

Note:

The operation differs according to the content of the Video CD.

Chapter (Track) skip

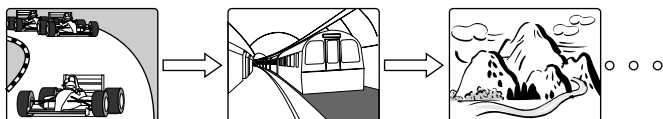

Skipping forward

Press the ►| button during play to skip to the next chapter (or track). A chapter (or track) is skipped each time the button is pressed.

Skipping back

Press the ◀◀ button during play to skip back to the beginning of the chapter (or track) currently played. Press the button again immediately to skip back to the beginning of the previous chapter (or track).

Note:

You can skip only through the chapters, not over the titles on the DVD disc.

Title search [DVD]

1. Press the SEARCH MODE button once during play or in the stop mode. "TITLE SEARCH..." screen appears.
2. Press the number button(s) to enter the title number. Play starts from the selected title.
Example:
To select No. 3, press 3.
To select No. 10, press ≥10, then 0.
To select No. 24, press ≥10, ≥10, then 4.

Chapter search [DVD]

1. Press the SEARCH MODE buttons twice during play. "CHAPTER SEARCH..." screen appears.
2. Press the number button(s) to enter the chapter number. Play starts from the selected chapter.

Track search [Video CD] [CD]

Press the number button(s) during play or in the stop mode. Play starts from the selected track.

Time search

[DVD]

1. Press the SEARCH MODE buttons three times during play. "TIME SEARCH..." screen appears.
2. Press the number button(s) to enter the time.
Example:
20 minutes 5 seconds Press 2, 0, 0 then 5.
1 hour 4 minutes 35 seconds Press 1, 0, 4, 3 then 5.
Note:
- Do not use the ≥10 button.
- If you made a mistake, press the CANCEL button.
3. Press the ► button. Play starts from the searched time.

[Video CD] [CD]

1. Press the SEARCH MODE buttons once during play. "TIME SEARCH..." screen appears.
2. Press the number button(s) to enter the time.
3. Press the ► button. Play starts from the searched time in the track.

Note:

- By repeating steps 1–3 in the stop mode, play starts at the searched time in the disc.

Note on the search function

- The search function of this system does not work during menu play of a Video CD with playback control.

Fast play

Press the SEARCH ►► or SEARCH ◀◀ button repeatedly to select the fast speed forward or reverse play.

[DVD] [Video CD]

"FF1 ►►", "FF2 ►►", "FF3 ►►" or "FR1 ◀◀", "FR2 ◀◀", "FR3 ◀◀"

[CD]

"FF1 ►►", "FF2 ►►" or "FR1 ◀◀", "FR2 ◀◀"

Press the ► button to return to normal play.

Slow-motion play

[DVD]: Forward and reverse slow play

Press the SLOW ►| or SLOW ◀| button repeatedly to select the forward or reverse slow speed play.

"SF1 ►|", "SF2 ►|", "SF3 ►|" or "SR1 ◀|", "SR2 ◀|", "SR3 ◀|"

[Video CD]: Forward slow play

Press the SLOW ►| button repeatedly to select the forward slow speed play.

"SF1 ►|", "SF2 ►|", "SF3 ►|"

Press the ► button to return to normal play.

Note:

The sound is muted during fast play or slow-motion play of a DVD and Video CD.

Still picture (Pause)

[DVD] [Video CD]: Still picture mode, [CD]: Pause mode

Press the || button during play.

Press the ► button to resume normal play.

Note: The sound is muted.

Frame by frame advance play [DVD] [Video CD]

Press the || button in the still picture mode. Each time the button is pressed, the picture advances one frame.

Press the ► button to resume normal play.

Note:

- The sound is muted.
- Frame play is operated forward only.

Picture zoom [DVD] [Video CD]

1. Press the SHIFT + 4 ZOOM buttons during play. The central part of the picture is magnified.

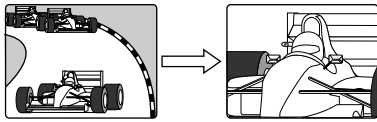

- Each time you press the SHIFT + 4 ZOOM buttons or press the RETURN button, the picture zooms in or out ("Zoom +15" – "Zoom -15").
 - Each time you press the ▲, ►, ▼ or ◀ button, the picture moves from side to side, up and down.
2. To return to normal play, press the CANCEL button.

Note:

Picture zoom operation may not work with some discs.

Viewing from a desired camera angle (Multi-Angle) [DVD]

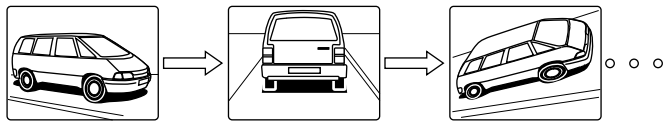

Some DVD discs may contain scenes which have been shot simultaneously from a number of different camera angles. The jacket or case of a disc that are recorded with multi-angle scenes will be marked.

Example:



Note: The recorded angles differ depending on the disc used.

1. Play the disc that is recorded with multi-angle scenes.
2. Press the SHIFT + 2 ANGLE buttons repeatedly until the desired angle appears.

Example:



Angle replay [DVD]

During playing a Multi-angle scene, press the SHIFT + 3 REPLAY buttons. The player skips back to last approximately 10 seconds, then changes it to the next camera angle and plays it, and continues play. (If desired, press both buttons again.)

Repeat play

Press the REPEAT button during play (or programmed play) of the title (or track) you want to repeat. Each time the button is pressed, the repeat mode changes as follows.

[DVD]

- ↶ Title (1 REP.): Repeat of the title being played
- ↶ Off: Normal play mode

[Video CD] [CD]

- ↶ 1 (1 REP.): Repeat of the track being played
- ↶ All (ALL REP.): Repeat all tracks
- ↶ Off: Normal play mode

Note:

- Repeat play mode may not work correctly with some discs.
- Repeat play does not work during menu play of a Video CD with playback control.

Programmed play [Video CD] [CD]

Up to 32 selections can be programmed.

Programming procedure

1. Press the PROGRAM button in the stop mode. "PROGRAM" screen appears. "PROG." flashes and "Pr 1" appears on the display.
2. Press the number button(s) to select the track number.

Example:

To select track No. 3, press 3.

To select track No.10, press 1, then 0.

To select track No.24, press 2, then 4.

Note:

- If you made a mistake, press the CANCEL button.
 - Do not use the ≥10 button.
 - Press the PROGRAM button to quit this menu.
3. Press the ENTER button. The highlighted box automatically moves to the next program number.

Example:

PROGRAM		Track Time
#	Track	
1	02	00 : 04 : 57
	--	
	--	
	--	
	--	
	--	
	--	
	--	

00 : 04 : 57

Total programmed time

4. Repeat step 2–3 above to select another track.
5. Press the ► button to start play. "PROG." remains lit. When all programmed selections have played, the player stops automatically.
 - The program contents are retained in memory.

To clear the program one by one

In the programming mode, press the ▲ or ▼ button to select the program number. Then press the CANCEL button.

To clear all the programs

In the programming mode, press the ■ button.

To change the program

1. In the programming mode, press the ▲ or ▼ button to select the program number.
2. Press the number button(s) to select the track number to be replaced, then press the ENTER button.

To use the program again with the same contents

Press the PROGRAM button to call up the "PROGRAM" screen, then press the ► button.

Selecting subtitle language [DVD]

This operation works only with discs on which multiple subtitle languages are recorded.

1. Press the SUBTITLE button during play. "SUBTITLE CHANGE" screen appears.
2. Press the ▲ button to select "On". The language is highlighted.

Example:

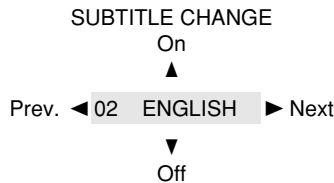

3. Press the ► or ◀ button to select the desired subtitle language, then press the SUBTITLE button.

Note:

- In some cases, the subtitle language is not changed to the selected one.
- When a disc supporting the closed caption is played, the subtitle and the closed caption may overlap each other on the TV screen. In this case, turn the subtitle off.
- When the desired language is not selected even if the button is pressed, the language is not available on the disc.
- When the power is turned on or the disc is replaced, select the subtitle language again.
- If the subtitle language is not necessary, select "Off".

Selecting audio soundtrack language (Multi-Language) [DVD]

This operation works only with discs on which multiple audio soundtrack languages are recorded.

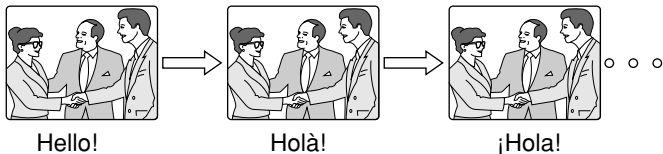

1. Press the AUDIO button during play.
2. Press the AUDIO button repeatedly until the desired language appears on the screen.

Example:

AUDIO CHANGE 04 FRENCH

Note:

- When the desired language is not selected even if the button is pressed, the language is not available on the disc.
- When the power is turned on or the disc is replaced, select the language again.
- If the desired language is not recorded on the disc, only the available language on the disc will be heard.
- This system automatically mutes the playback sound temporarily in order to prevent a noise from generating when the audio soundtrack language is switched to another. So, if the playback is muted temporarily when you switch the audio soundtrack language to another on a disc that has two or more audio soundtrack languages, this is not a malfunction of this system.

Changing the audio channel output [Video CD]

During a Video CD play, press the AUDIO buttons to select an audio channel.

LEFT MONO → RIGHT MONO → STEREO → LEFT MONO ...

Selecting on-screen information

Press the ON SCREEN button repeatedly to show the disc information (Title, Chapter, current title's elapsed playing time, Language, etc.).

Example for DVD:

1. Press the ON SCREEN button.

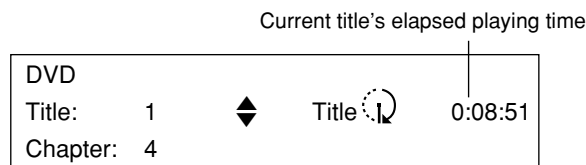

By pressing the ▲ or ▼ button, the title or chapter information changes.

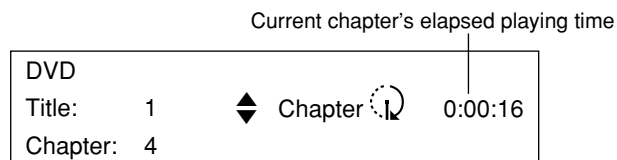

2. Press the ON SCREEN button.

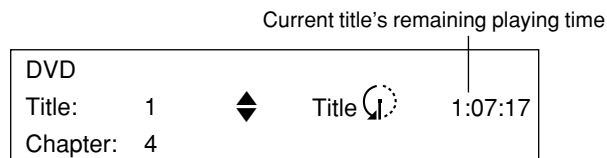

By pressing the ▲ or ▼ button, the title or chapter information changes.

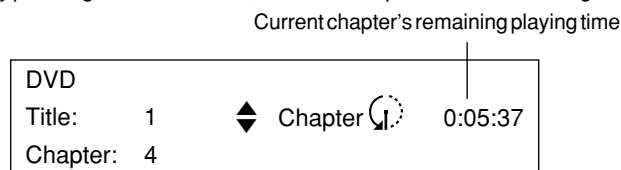

3. Press the ON SCREEN button.

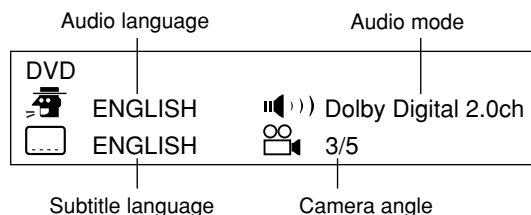

Note:

The ▲ or ▼ button can be used only on the active screen while "ON SCREEN" is working.

Example for VCD:

1. Press the ON SCREEN button.

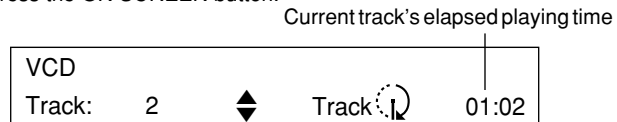

By pressing the ▲ or ▼ button, the track or disc information changes.



2. Press the ON SCREEN button.

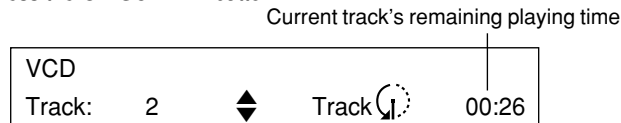

By pressing the ▲ or ▼ button, the track or disc information changes.



Note:

For Music CDs, please refer to "Example for VCD" as above.

MP3 CD OPERATION

This player can play back CD-R/RWs that have recorded music data or MP3 files. Before playing back an MP3 CD, please read the following.

MP3 CD information

Limitations on MP3 CD play

- This player can recognize up to 255 files or folders per disc. The CD with 256 files or folders and more is not available on this player.
- This player can recognize up to 8 directory trees per disc.
- MP3 CDs may not be played in the recorded order.
- As for a multi-session disc, only the first session can be played.
- If the CD has both audio tracks and MP3 files, only audio tracks are played.
- It would take 30 seconds or more for this player to read MP3 files depending on its structure.

Limitations on the display

- The display can show up to 33 letters at a time. Available letters on the display are the following: capital or small alphabets of A through Z, numbers of 0 through 9, and _ (underline).
- Other letters than those above are replaced in blank.

Notes on MP3 files

- The recommend recording setting for a high-quality sound is 44.1 kHz of sampling frequency and 128 kbps of fixing bit rate.
- To play an MP3 CD in the recorded order,
 1. Please use the MP3 software with the function that can record data alphabetically or numerically.
 2. Put the name including two-digit or three-digit number like "01", "02" or "001", "002" on each file.
 3. Please refrain from making many sub-folders by preference.
- Some MP3 CDs can not be played back depending on the recording conditions.

MP3 CD Play

1. Load an MP3 CD.

A table of contents in the root directory appears on the TV screen.

Example: (the root directory)

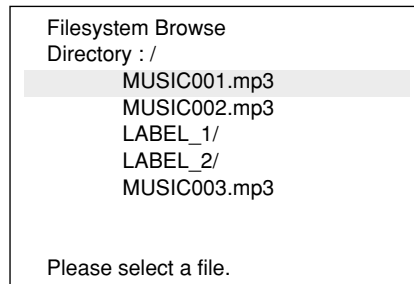

Note:

If nothing appears on the TV screen, press the MENU button.

2. Select the desired file by pressing the ▲ or ▼ button. The selected file is highlighted.
 - To go on to the next directory, select the appropriate folder and press the ► button. A table of contents in the selected directory appears on the TV screen.
 - To go back to the previous directory, press the ◀ button.
 - You can go on up to the eighth directory.
3. Press the ENTER (or ►) button to start playback. Elapsed playing time and total playing time in current file are displayed on the TV screen.

Example: (the second directory)

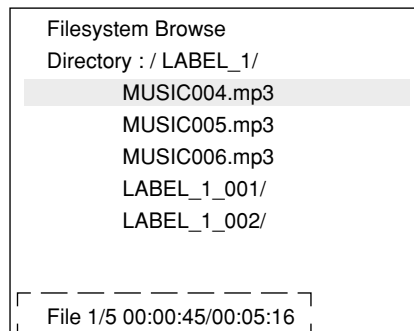

File information

Notes on file skip

Skipping forward

Press the ►► button during play to skip to the next file. Each time the button is pressed, a file is skipped within the same directory.

Skipping back

Press the ◀◀ button during play to skip back to the beginning of the file currently played. Press the button again immediately to skip back to the beginning of the previous file.

Note:

- The files with no-MP3 extension and the folders are automatically skipped.
- To roll up and down the display, press the ▲ and ▼ buttons respectively.

LANGUAGE CODE LIST

Enter the appropriate code number for the settings "AUDIO", "SUBTITLE" and "DVD MENU" on the SET UP MENU.

Code	Abbreviation of the language	Language	Code	Abbreviation of the language	Language	Code	Abbreviation of the language	Language
6565	aa	Afar	7369	ie	Interlingue	8278	rn	Kirundi
6566	ab	Abkhazian	7375	ik	Inupiak	8279	ro	Romanian
6570	af	Afrikaans	7378	in	Indonesian	8285	ru	Russian
6577	am	Amharic	7383	is	Icelandic	8287	rw	Kinyarwanda
6582	ar	Arabic	7384	it	Italian	8365	sa	Sanskrit
6583	as	Assamese	7387	iw	Hebrew	8368	sd	Sindhi
6589	ay	Aymara	7465	ja	Japanese	8371	sg	Sangro
6590	az	Azerbaijani	7473	ji	Yiddish	8372	sh	Serbo-Croatian
6665	ba	Bashkir	7487	jw	Javanese	8373	si	Singhalese
6669	be	Byelorussian	7565	ka	Georgian	8375	sk	Slovak
6671	bg	Bulgarian	7575	kk	Kazakh	8376	sl	Slovenian
6672	bh	Bihari	7576	kl	Greenlandic	8377	sm	Samoan
6673	bi	Bislama	7577	km	Cambodian	8378	sn	Shona
6678	bn	Bengali; Bangla	7578	kn	Kannada	8379	so	Somali
6679	bo	Tibetan	7579	ko	Korean	8381	sq	Albanian
6682	br	Breton	7583	ks	Kashmiri	8382	sr	Serbian
6765	ca	Catalan	7585	ku	Kurdish	8383	ss	Siswati
6779	co	Corsican	7589	ky	Kirghiz	8384	st	Sesotho
6783	cs	Czech	7665	la	Latin	8385	su	Sundanese
6789	cy	Welsh	7678	ln	Lingala	8386	sv	Swedish
6865	da	Danish	7679	lo	Laothian	8387	sw	Swahili
6869	de	German	7684	lt	Lithuanian	8465	ta	Tamil
6890	dz	Bhutani	7686	lv	Latvian, Lettish	8469	te	Tegulu
6976	el	Greek	7771	mg	Malagasy	8471	tg	Tajik
6978	en	English	7773	mi	Maori	8472	th	Thai
6979	eo	Esperanto	7775	mk	Macedonian	8473	ti	Tigrinya
6983	es	Spanish	7776	ml	Malayalam	8475	tk	Turkmen
6984	et	Estonian	7778	mn	Mongolian	8476	tl	Tagalog
6985	eu	Basque	7779	mo	Moldavian	8478	tn	Setswana
7065	fa	Persian	7782	mr	Marathi	8479	to	Tonga
7073	fi	Finnish	7783	ms	Malay	8482	tr	Turkish
7074	fj	Fiji	7784	mt	Maltese	8483	ts	Tsonga
7079	fo	Faeroese	7789	my	Burmese	8484	tt	Tatar
7082	fr	French	7865	na	Nauru	8487	tw	Twi
7089	fy	Frisian	7869	ne	Nepali	8575	uk	Ukrainian
7165	ga	Irish	7876	nl	Dutch	8582	ur	Urdu
7168	gd	Scots Gaelic	7879	no	Norwegian	8590	uz	Uzbek
7176	gl	Galician	7967	oc	Occitan	8673	vi	Vietnamese
7178	gn	Guarani	7977	om	(Afan) Oromo	8679	vo	Volapük
7185	gu	Gujarati	7982	or	Oriya	8779	wo	Wolof
7265	ha	Hausa	8065	pa	Punjabi	8872	xh	Xhosa
7273	hi	Hindi	8076	pl	Polish	8979	yo	Yoruba
7282	hr	Croatian	8083	ps	Pashto, Pushto	9072	zh	Chinese
7285	hu	Hungarian	8084	pt	Portuguese	9085	zu	Zulu
7289	hy	Armenian	8185	qu	Quechua			
7365	ia	Interlingua	8277	rm	Rhaeto-Romance			

LISTENING TO VIDEO SOURCES

1. Press the INPUT button to select "VIDEO 1" or "VIDEO 2".
2. Follow the instructions supplied with the VCR or other video equipment.

LISTENING TO THE RADIO

To turn the unit on and listen to the last received station, press the TUNER button on the remote control.

Automatic/Manual tuning

1. Press the INPUT or TUNER button to select FM or AM.

When using the remote control, press the TUNER button instead of the INPUT button.

2. Automatic tuning

Press the TUNING + or TUNING – button for at least 1 second to tune in a station. The unit will scan up or down the band and receive the next receivable station. Press the button again to continue.

Manual tuning

Press the TUNING + or TUNING – button briefly until the desired frequency is displayed.

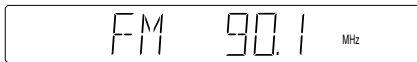

(U.S.A. and Canada models)

To preset stations

Up to 20 FM and 10 AM stations can be preset.

Automatic presetting (APT)

1. Press the INPUT or TUNER button to select FM or AM.
2. Press the MEMORY button for at least 3 seconds. "PROG." flashes. The automatic tuning mode is set and automatic presetting begins from the low end of the band. When 20 FM or 10 AM stations have been preset or the high end of the band is reached, automatic presetting stops. "PROG." disappears and the station memorized on channel 1 will be heard.
3. To preset stations on the other band, follow steps above.

Note:

If APT is activated, all previously programmed stations of the band will be cleared and new stations will be programmed.

Manual presetting

1. Tune in the station to be preset as described in "Automatic/Manual tuning".
2. Press the MEMORY button.

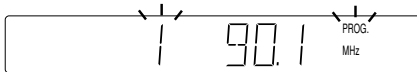

(U.S.A. and Canada models)

3. While "PROG." is flashing, press the PRESET button to select the channel to be preset.

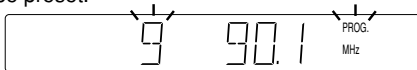

(U.S.A. and Canada models)

4. While "PROG." is flashing, press the MEMORY button.
 - In this example, "90.1 MHz" FM station is preset on FM channel 9.

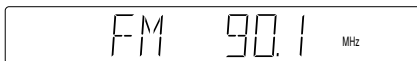

(U.S.A. and Canada models)

5. Repeat steps above to add more preset stations.
 - When presetting a new station, the previous preset station is cleared.

Listening to preset stations

1. Press the INPUT or TUNER button to select FM or AM.
2. Press the PRESET button briefly to select the desired channel.
 - The number buttons on the remote control can also be used. Example: Press 0, then 9.

Preset scan tuning

1. Press the INPUT or TUNER button to select FM or AM.
2. Press the PRESET button for at least 1 second. The channel number appears. Each of the preset stations is tuned in for 5 seconds.
 - The PRESET button on the remote control can also be used.
3. When the desired station has been tuned in, press the PRESET button again to keep the reception locked at that station.

To receive FM stereo broadcasts

Make sure that "MONO" is not displayed. If "MONO" appears, press the FM MODE button to turn the "MONO" indication off.

"ST" appears when an FM stereo broadcast is received.

- If the signal from an FM stereo station is weak and reception is poor, press the FM MODE button to change to the MONO mode. The reception may be improved, but the sound will be monaural.

TIMER OPERATION (Using the remote control)

Using the timer

Set the time when the timer turns on and off, source to be used and volume level. Timer operation will start with the selected source at the "on" time. The power will be switched off at the "off" time. The timer will function every day unless it is released.

Preparation

Note:

Make absolutely sure that the clock is set to the correct time before setting the timer.

- Select the source for timer operation and prepare the source to be used.
 - If the selected source is the tuner, tune in to the desired band and station.
- Adjust the volume level as desired.

Operation

1. Press the SHIFT + 7 TIMER buttons.

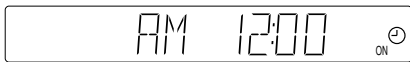

The previously set timer "on" time setting appears.

2. Press the SHIFT + 8 ADJUST buttons within 15 seconds.

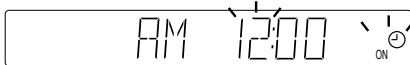

3. Set the hour of the "on" time by pressing the TUNING - or + button, then press the SHIFT + 8 ADJUST buttons.

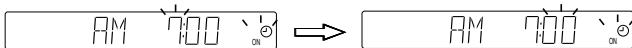

Set the minute in the same way.

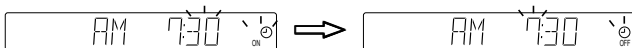

The timer "off" time setting appears.

4. Set the timer "off" time as described in step 3. "OFF" blinks.
5. While "OFF" is flashing, press the INPUT button to select the source to be used.
6. Press the SHIFT + 8 ADJUST buttons. The timer operation standby mode is activated. "OFF" remains lit.
7. Press the STANDBY/ON button to switch off the power.
 - "OFF" disappears from the display when this system is turned into the standby mode.
 - To switch off the power during a timer-controlled operation, press the STANDBY/ON button. The timer will be set in the standby mode.

To check the timer settings

Press the SHIFT + 7 TIMER buttons repeatedly. The timer settings are displayed in the following order:

On time → Off time → Source

To change the settings, press the SHIFT + 7 TIMER buttons to select the setting to be changed, then press the SHIFT + 8 ADJUST buttons to make the display flash. Change the setting as explained above.

To release the timer

After turning the power on, press the SHIFT + 7 TIMER buttons, then press the SHIFT + SET/CLEAR.

Note:

- If the SHIFT + SET/CLEAR buttons are pressed while the timer is being set, the original display returns.
- The timer mode is released if a power failure occurs during timer controlled operation.
- The timer may not operate if a power failure occurs during timer operation standby mode.

Using the sleep timer

The sleep timer automatically switches off the power after a preset time has elapsed. The volume will gradually be reduced (faded-out) from 1-minute before the unit turns off. There are 9 time periods available: 90, 80, 70, 60, 50, 40, 30, 20, and 10 minutes.

Press the SHIFT + 6 SLEEP buttons repeatedly to select the desired sleep time. "SLEEP" appears on the display. After several seconds, the original display returns and the brightness of the display reduces.

To check the remaining sleep time

Press the SHIFT + 6 SLEEP buttons once. After several seconds, the original display returns.

To release the sleep timer while in operation

Press the SHIFT + SET/CLEAR buttons. The timer is also released if the power is switched off.

TROUBLESHOOTING GUIDE

If you have followed the instructions and are having difficulty in operating the unit, locate the SYMPTOM in the left column below. Check the corresponding POSSIBLE CAUSE and CORRECTIVE ACTION columns to locate and remedy the problem.

SYMPTOM	POSSIBLE CAUSE	CORRECTIVE ACTION
No picture.	An improper source is selected.	Select the correct source.
	No disc is loaded or an unplayable disc is loaded.	Load a disc or load a playable disc. (Check the disc logo, type, color system and regional code.)
	The TV is not set to receive signal from the unit.	Select the correct input function on the TV.
No sound.	An improper source is selected.	Select the correct source.
	Volume control is set to minimum.	Turn up the volume.
The playback picture is poor.	An unplayable disc is loaded.	Load a playable disc. (Check the disc logo, type, color system and regional code.)
"⊘" appears on the TV screen.	The selected function does not operate on the current disc.	The feature or action cannot be completed at this time because: <ul style="list-style-type: none"> - The feature is not available at the moment. - The DVD software restricts it. - The DVD software does not support the feature (e.g., angles).
The DVD player does not start play.	No disc is loaded.	Load a disc.
	An unplayable disc is loaded.	Load a playable disc. (Check the disc logo, type, color system and regional code.)
	The disc is loaded with the label side down.	Load the disc on the disc tray correctly.
	The disc is dirty.	Clean the disc or replace it.
	"PARENTAL" is set.	Cancel the parental lock function or change the rating level. Reset it after play.
The operation or display is not normal.	The memory must be reset.	<ol style="list-style-type: none"> 1. Disconnect the power cable of the unit. 2. While pressing both BASS and MUSIC buttons at the same time, connect the power cable. 3. Resume operation.
The remote control does not work properly.	The batteries in the remote control are weak, or installed incorrectly.	Check the battery polarity (+ or -). Replace the batteries.
	The remote control is not aimed at the remote control sensor.	Aim the remote control at the remote control sensor.

For customers using a TV without progressive scanning capability (U.S.A., Canada and Korean models only)

There may be the following case if the VIDEO OUT SCAN SELECT switch on the rear of the unit is set to SELECTABLE and the VIDEO OUT SELECT switch to COMPONENT.

If you select COMPONENT OUTPUT: PROGRESSIVE on "Display" in the SET UP MENU while watching a picture played back on this system, no picture is displayed on the TV.

In such a case, set the VIDEO OUT SELECT switch to INTERLACE, then turn this system off and on again. The picture will be displayed on the TV.

SPECIFICATIONS

AMPLIFIER SECTION

- Output Power
 - FRONT L/R, CENTER, SURROUND L/R
 - 1 kHz, 10% THD, 8 Ω 35 W
 - SUBWOOFER
 - 100 Hz, 10% THD, 8 Ω 40 W
 - [U.S.A. and Canada models]
 - FRONT L/R, CENTER, SURROUND L/R
 - 1 kHz, 0.9% THD, 8 Ω 30 W
 - SUBWOOFER
 - 100 Hz, 0.9% THD, 8 Ω 35 W
- Inputs
 - VIDEO 1 (RCA)
 - AUDIO Analog
 - VIDEO Composite
 - VIDEO 2 (RCA)
 - [U.S.A., Canada, Australia, China, Korean and General models]
 - AUDIO Analog
 - VIDEO Composite
 - VIDEO 2 (EURO AV)
 - [U.K. and Europe models]
 - AUDIO Analog
 - VIDEO Composite
 - Outputs
 - VIDEO 1 (RCA)
 - AUDIO Analog
 - VIDEO Composite
 - MONITOR OUT
 - VIDEO (RCA) Composite
 - S-VIDEO DVD only
 - COMPONENT
 - [U.S.A., Canada, Australia, China, Korean and General models] .. DVD only
 - EURO AV
 - [U.K. and Europe models]
 - AUDIO Analog
 - VIDEO RGB (DVD only) & Composite
 - SPEAKERS
 - FRONT L/R 8 Ω
 - CENTER 8 Ω
 - REAR L/R 8 Ω
 - SUBWOOFER 8 Ω

DVD PLAYER SECTION

- Type DVD video player
- Playback standard
 - [U.S.A., Canada and Korean models] NTSC
 - [U.K., Europe, Australia, China and General models] PAL
- Laser Semiconductor laser, wavelength: 650/790 nm
- Laser output (Continuous wave max.) 1 mW (DVD)
0.5 mW (CD)
- Signal to Noise Ratio (IHF-A Network, shorted) More than 105 dB
- Total Harmonic Distortion 0.003 %
- Wow and flutter Below measurable level

TUNER SECTION

- FM Tuning Range
 - [U.S.A. and Canada models] 87.9 to 107.9 MHz
 - [Other models] 87.50 to 108.00 MHz
- AM Tuning Range
 - [U.S.A. and Canada models] 520 to 1710 kHz
 - [U.K. and Europe models] 522 to 1611 kHz
 - [Australia, China and Korean models] 522 to 1710 kHz
 - [General model] 522/520 to 1710 kHz

SPEAKER SECTION

- Front and Surround Speakers
 - Model Name NX-S60S
 - Type Acoustic suspension
 - Speakers 5 cm (2 inch) full range cone x 2, magnetic shielding
 - Impedance 8 Ω
- Center Speaker
 - Model Name NX-S60C
 - Type Acoustic suspension
 - Speakers 5 cm (2 inch) full range cone x 2, magnetic shielding
 - Impedance 8 Ω
- Subwoofer
 - Model Name SW-S60
 - Speaker Passive 16 cm (6-1/2 inch) cone woofer, magnetic shielding
 - Impedance 8 Ω

GENERAL

- Power Supply
 - [U.S.A. and Canada models] AC 120 V/60 Hz
 - [Australia model] AC 230–240 V/50 Hz
 - [U.K. and Europe models] AC 230 V/50 Hz
 - [China model] AC 220 V/50 Hz
 - [Korean model] AC 220 V/60 Hz
 - [General model] AC 110–120/220–240 V, 50/60 Hz
- Power Consumption
 - [U.S.A., Canada and Korean models] 230 W
 - [U.K., Europe, Australia, China and General models] 170 W
- Standby Power Consumption
 - DVR-S60 1.8 W
- Dimensions (W x H x D)
 - DVR-S60 435 x 90 x 381 mm
(17-1/8" x 3-9/16" x 15")
 - SW-S60 200 x 351 x 206 mm
(7-7/8" x 13-13/16" x 8-1/8")
 - NX-S60C 300 x 72 x 110 mm
(11-13/16" x 2-13/16" x 4-5/16")
 - NX-S60S 72 x 164 x 111 mm
(2-13/16" x 6-7/16" x 4-3/8")
- Weight
 - DVR-S60 8.0kg
(17 lbs 10 oz)
 - SW-S60 4.8kg
(10 lbs 9 oz)
 - NX-S60C 1.1kg
(2 lbs 7 oz)
 - NX-S60S 0.9kg
(2 lbs)



YAMAHA ELECTRONICS CORPORATION, USA 6660 ORANGETHORPE AVE., BUENA PARK, CALIF. 90620, U.S.A.
YAMAHA CANADA MUSIC LTD. 135 MILNER AVE., SCARBOROUGH, ONTARIO M1S 3R1, CANADA
YAMAHA ELECTRONIK EUROPA G.m.b.H. SIEMENSSTR. 22-34, 25462 RELLINGEN, BEI HAMBURG, F.R. OF GERMANY
YAMAHA ELECTRONIQUE FRANCE S.A. RUE AMBROISE CROIZAT BP70 CROISSY-BEAUBOURG 77312 MARNE-LA-VALLÉE CEDEX02, FRANCE
YAMAHA ELECTRONICS (UK) LTD. YAMAHA HOUSE, 200 RICKMANSWORTH ROAD WATFORD, HERTS WD1 7JS, ENGLAND
YAMAHA SCANDINAVIA A.B. J A WETTERGRENS GATA 1, BOX 30053, 400 43 VASTRA FRÖLUNDA, SWEDEN
YAMAHA MUSIC AUSTRALIA PTY, LTD. 17-33 MARKET ST., SOUTH MELBOURNE, 3205 VIC., AUSTRALIA

YAMAHA CORPORATION

Printed in China  V969660-2